

Jump Comics

ドラゴンボール

# DRAGONBALL

by Toriyama Akira



# 09

鳥山明

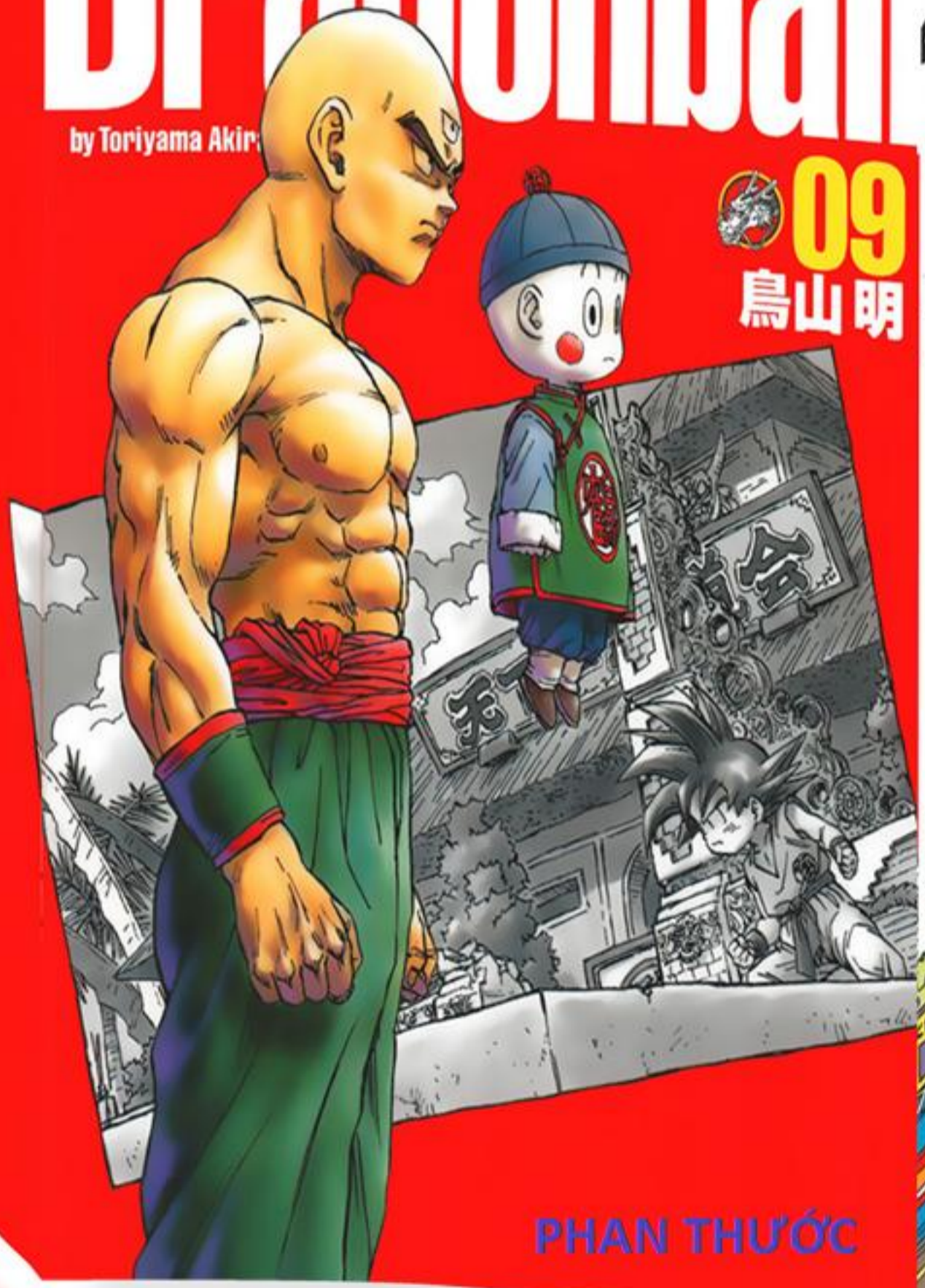

ドラゴンボール  
09 ドラゴンボール 鳥山明  
by Toriyama Akira, Jump Comics, © Shueisha  
SHUEISHA

PHAN THƯ ỨC

# Dragonball | 09 | contents



● Chương 120	<b>CẢN THẬN NÀO! DODONPA ĐẤY!</b>	<b>005</b>
● Chương 121	<b>KẾ HOẠCH CỦA KURIRIN</b>	<b>021</b>
● Chương 122	<b>GOKUU VS. PAMPUTT</b>	<b>036</b>
● Chương 123	<b>TIEN SHINHAN VS. JACKIE CHUN</b>	<b>051</b>
● Chương 124	<b>SỨC MẠNH CỦA TUỔI TRẺ</b>	<b>065</b>
● Chương 125	<b>GOKUU VS. KURIRIN PART.1</b>	<b>079</b>
● Chương 126	<b>GOKUU VS. KURIRIN PART.2</b>	<b>094</b>
● Chương 127	<b>GOKUU VS. KURIRIN PART.3</b>	<b>108</b>
● Chương 128	<b>GOKUU VS. TIEN SHINHAN</b>	<b>122</b>
● Chương 129	<b>ĐẤU BÓNG CHUYỂN CHỤT NÀO!</b>	<b>136</b>
● Chương 130	<b>THÀI DƯƠNG HẠ SAN!</b>	<b>150</b>
● Chương 131	<b>TSURU-SENNIN</b>	<b>165</b>
● Chương 132	<b>ĐỘ TAY!</b>	<b>180</b>
● Chương 133	<b>LIỀU LĨNH TỘT CÙNG!</b>	<b>194</b>
● Chương 134	<b>TRÊN KHÔNG TRUNG</b>	<b>208</b>
	<b>EXTRA</b>	<b>223</b>



№120 - CÂN THẬN NÀO! DODONPA ĐÂY!









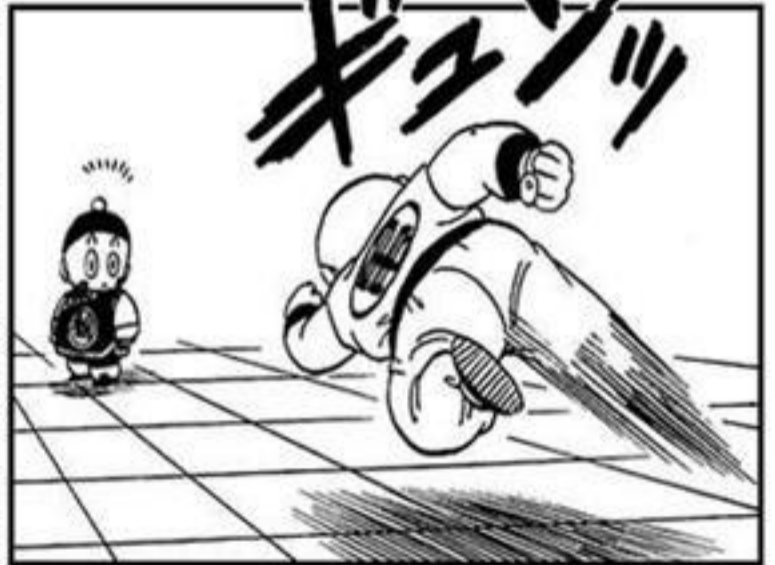
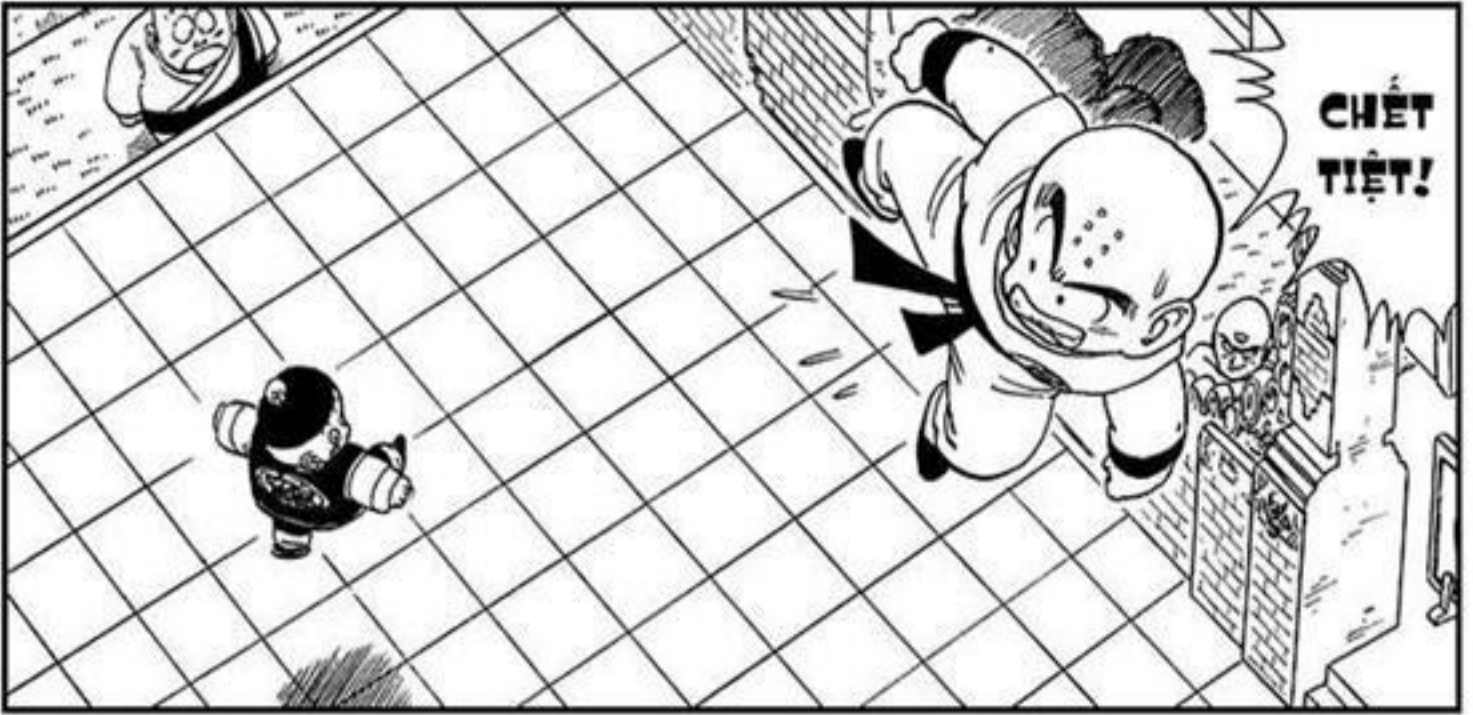











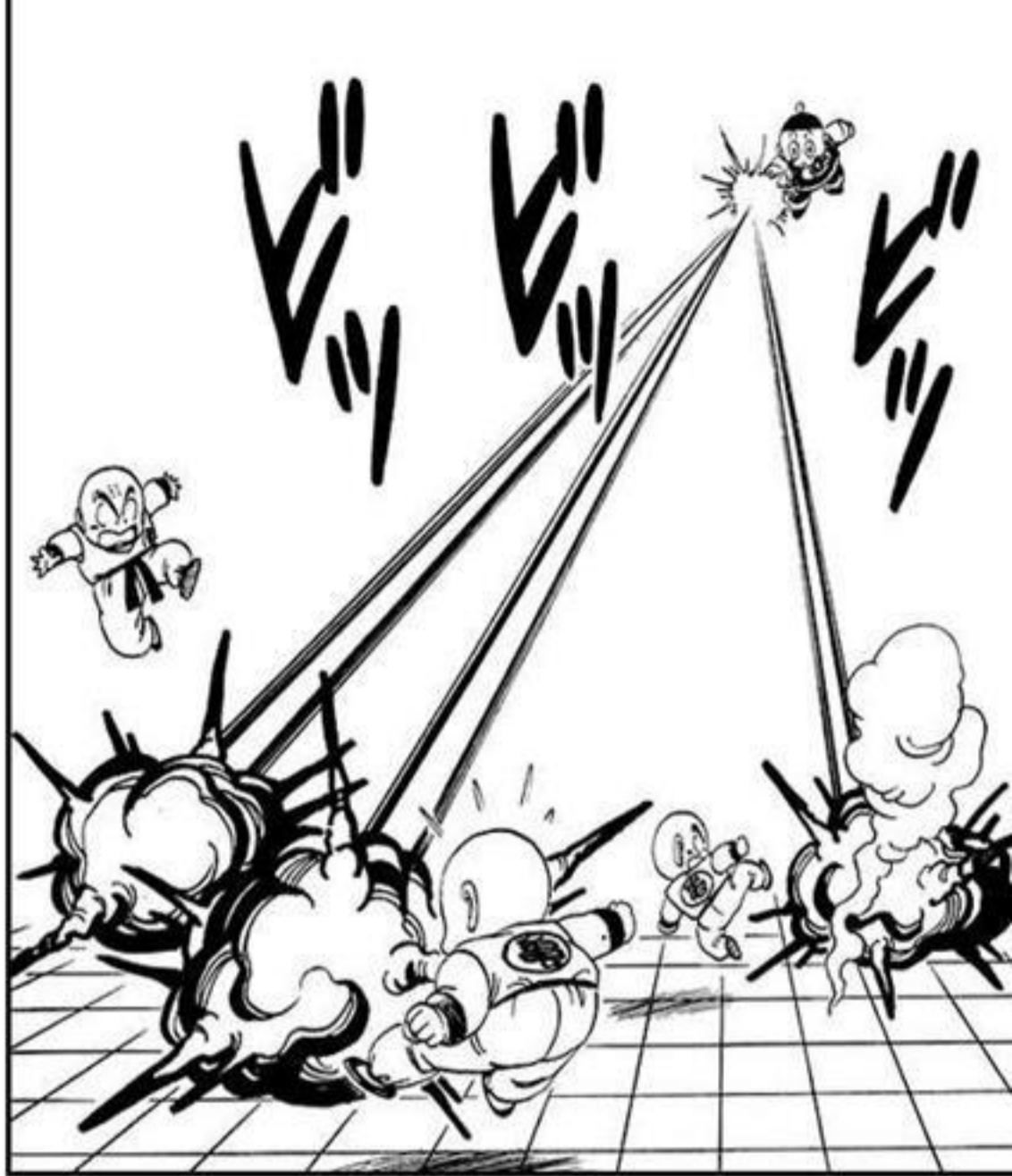



NGƯỜI COI TA LÀ KẸ NÓI DỐI SAO?

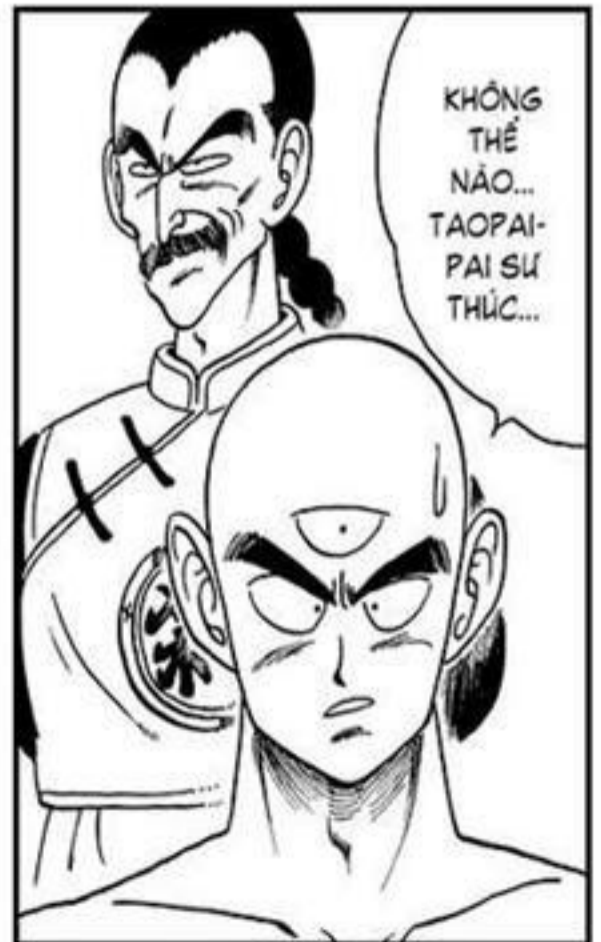



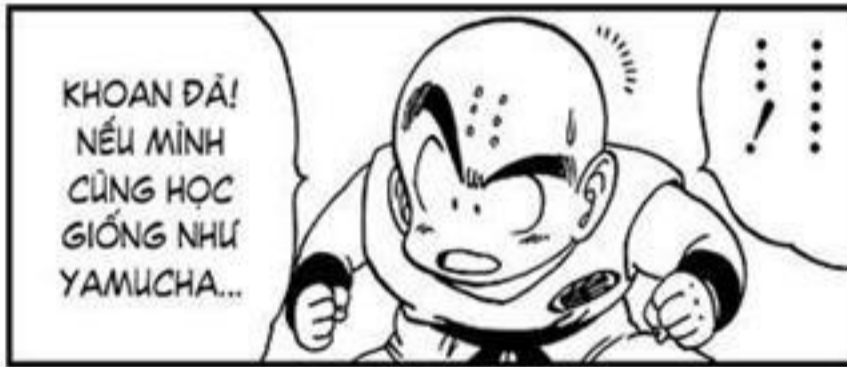







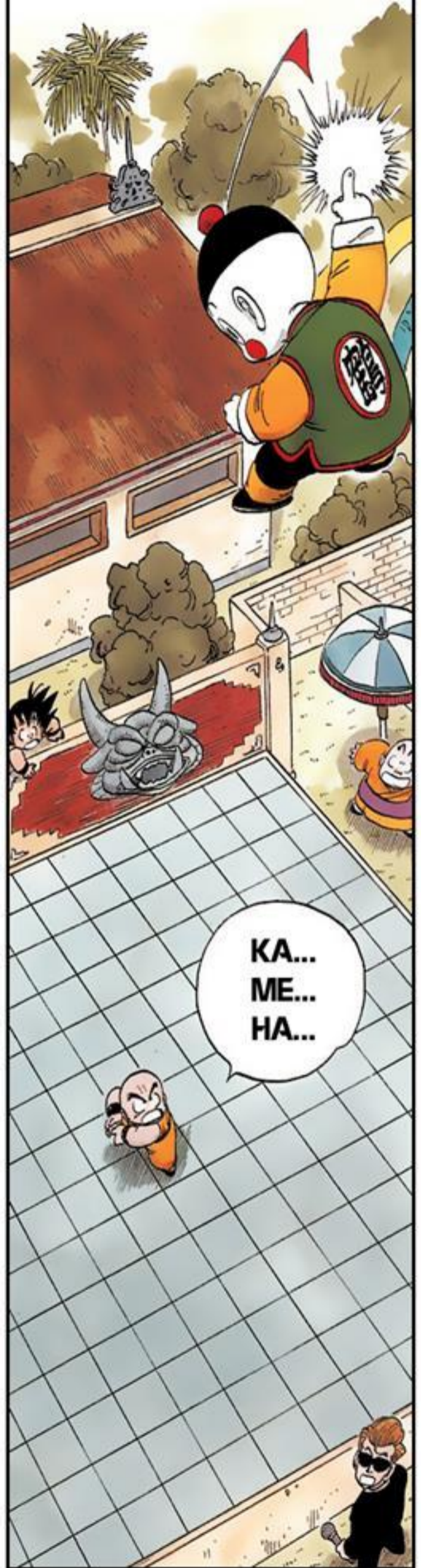

№121 - KẾ HOẠCH CỦA KURIRIN

# DRAGON BALL

ドラゴンボール



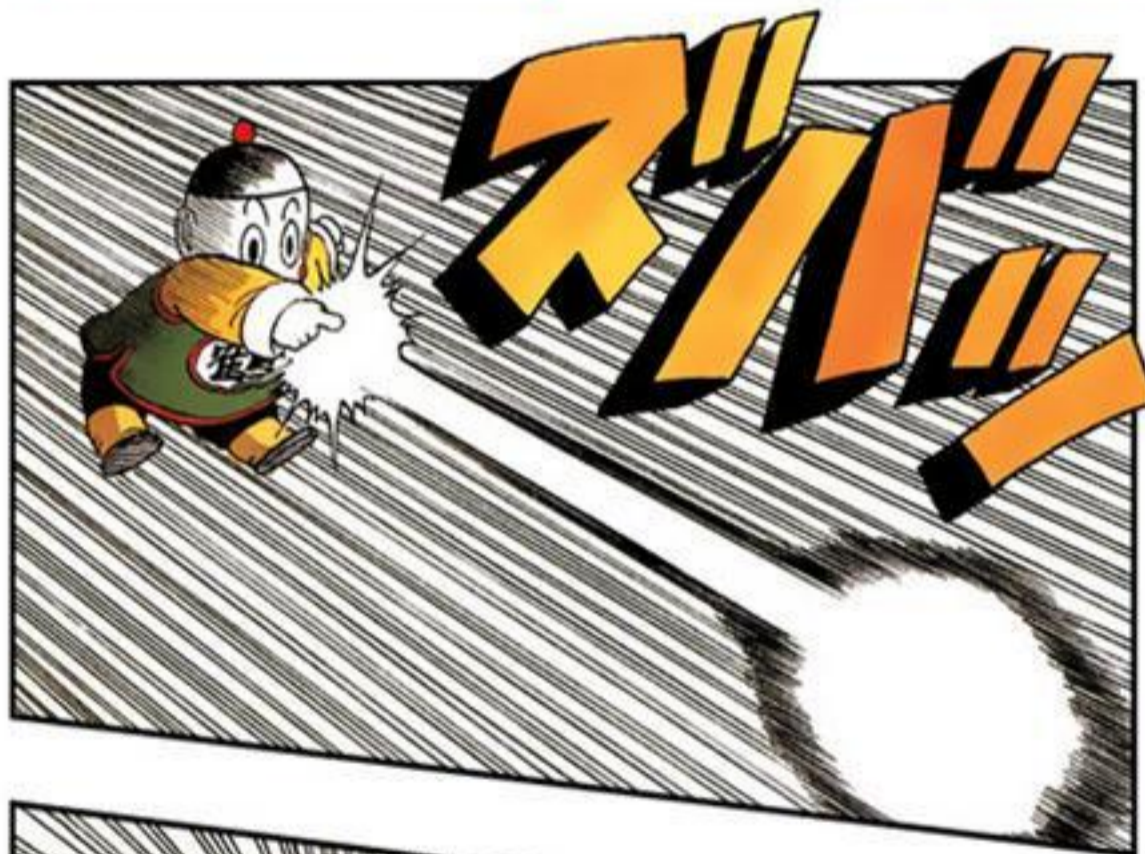

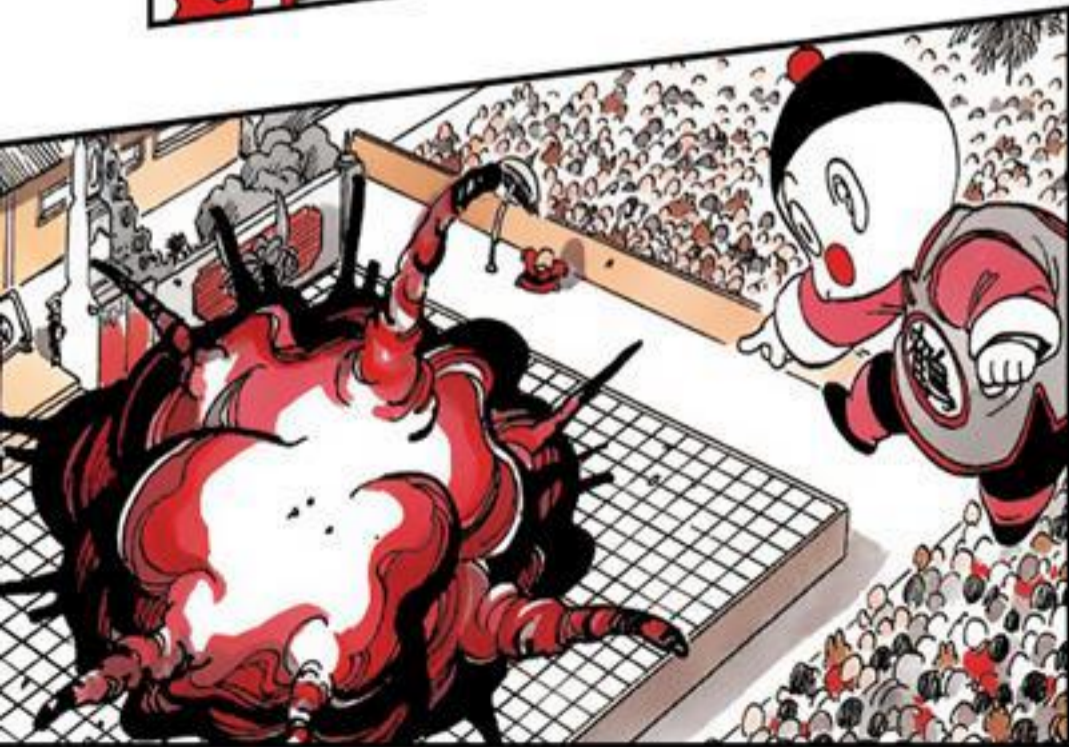

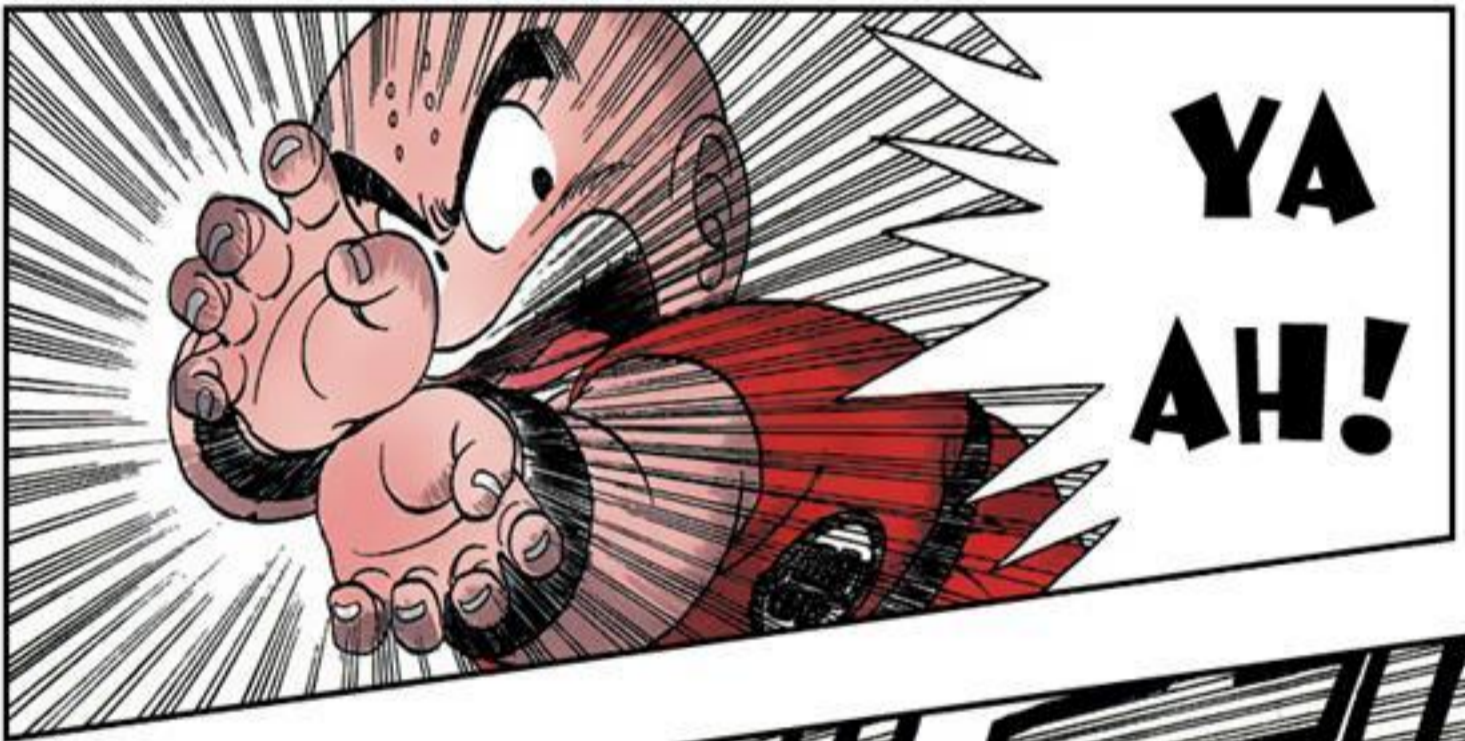

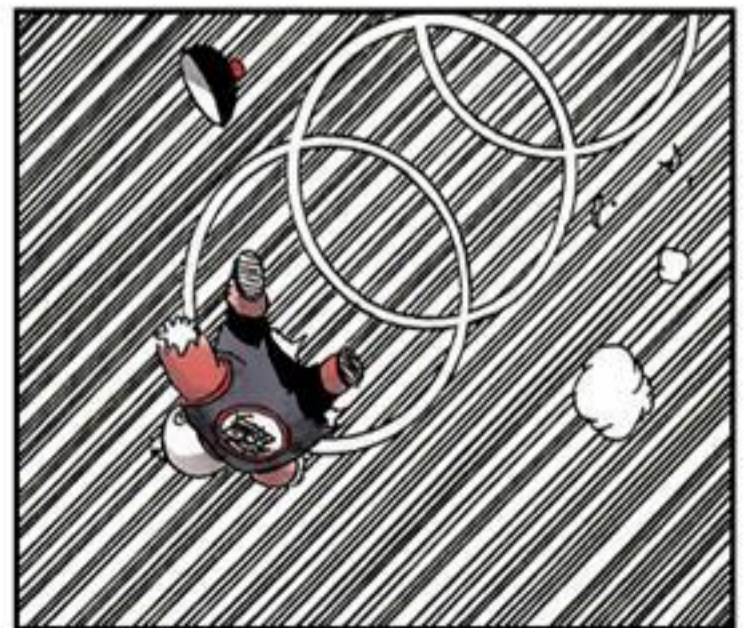
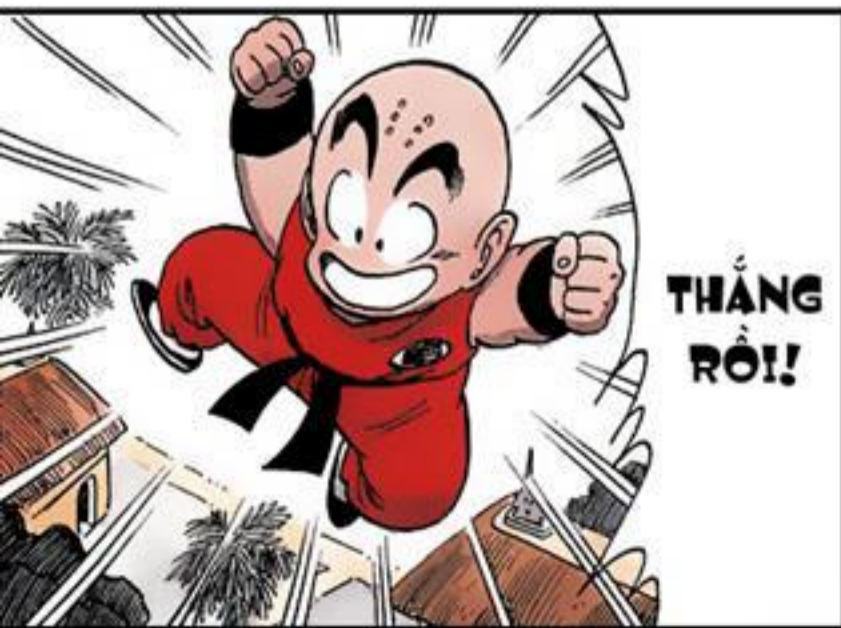
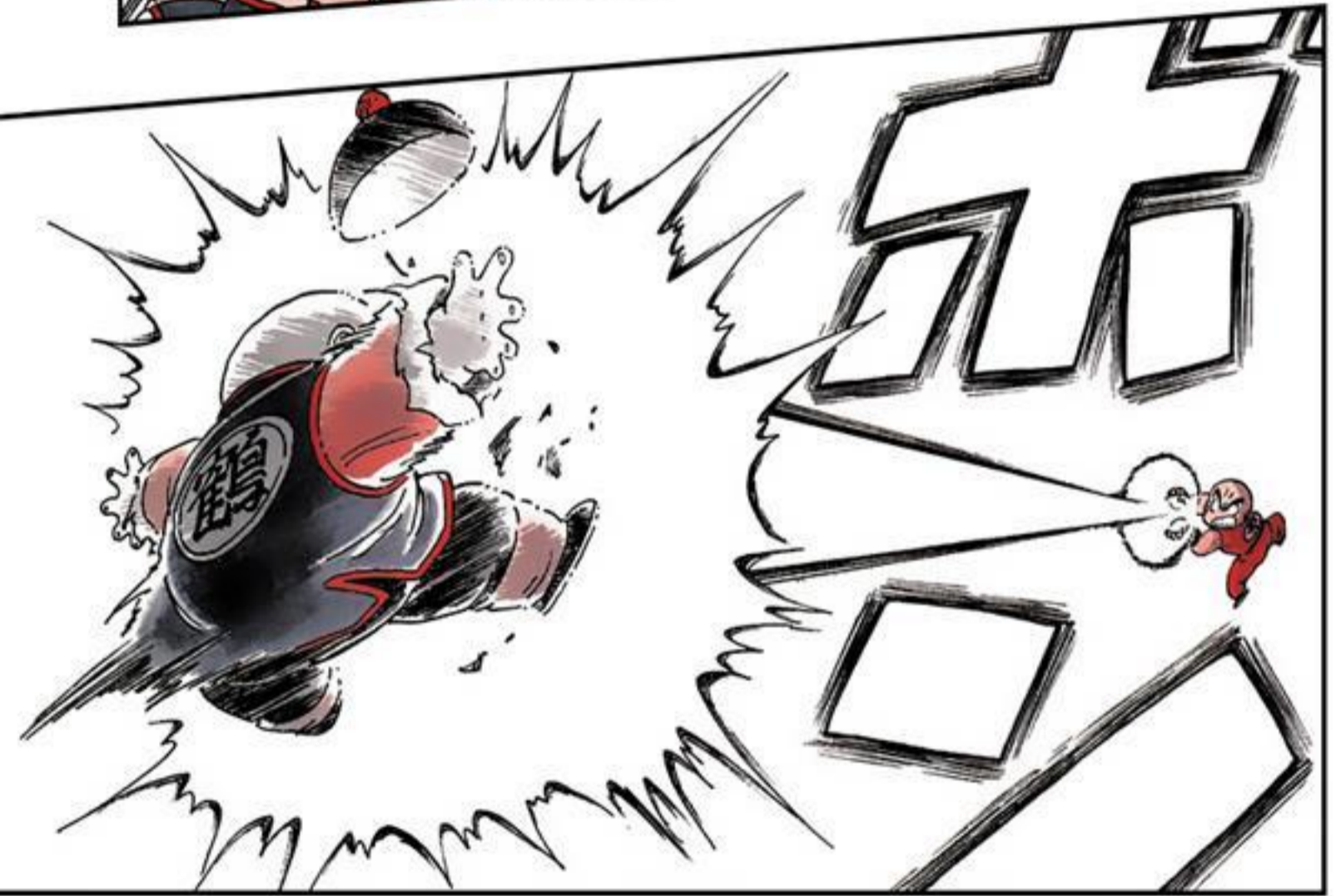

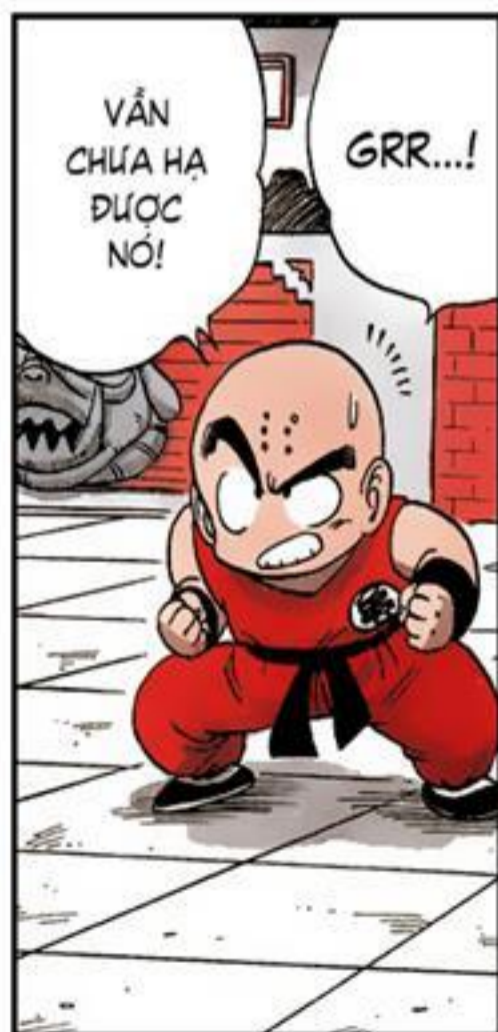



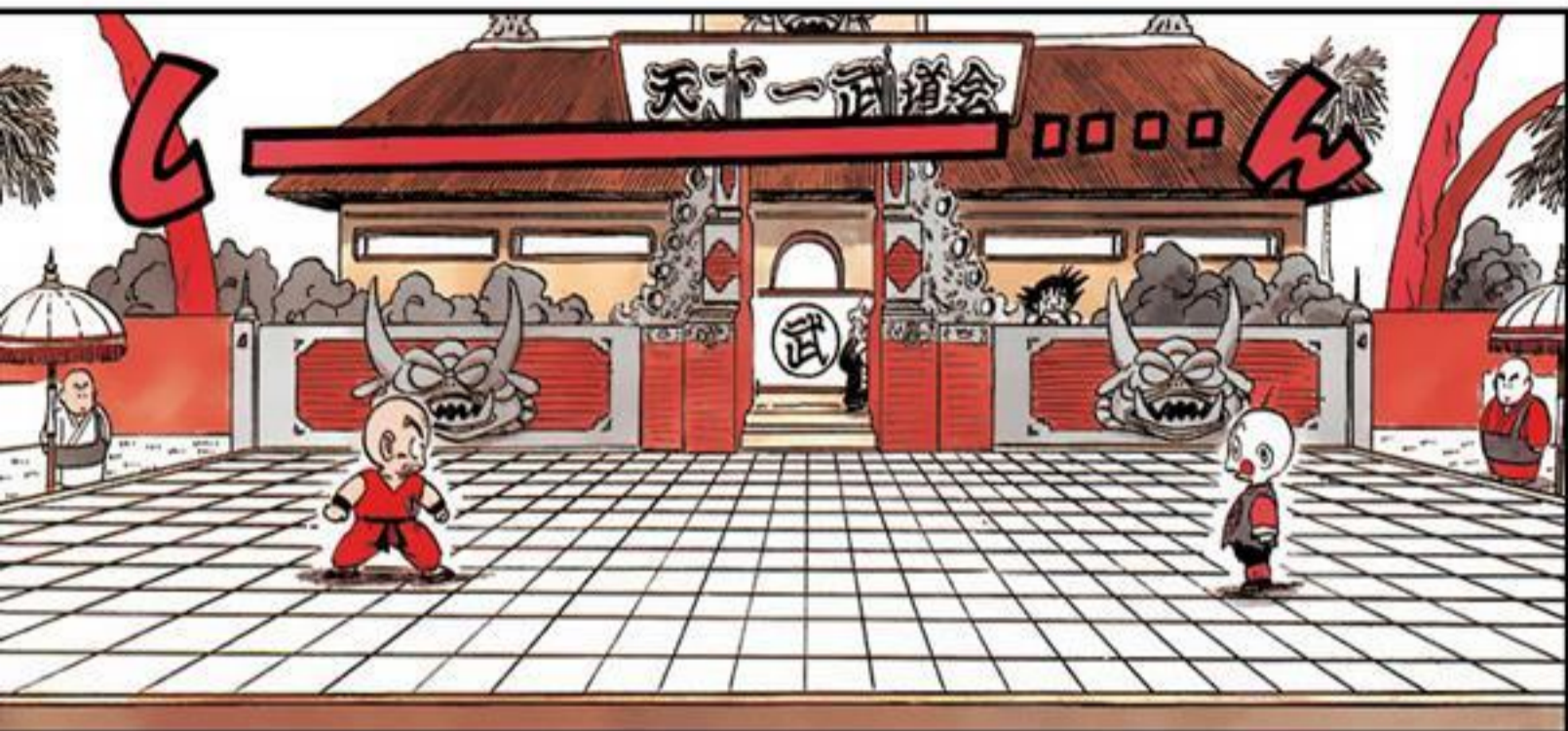

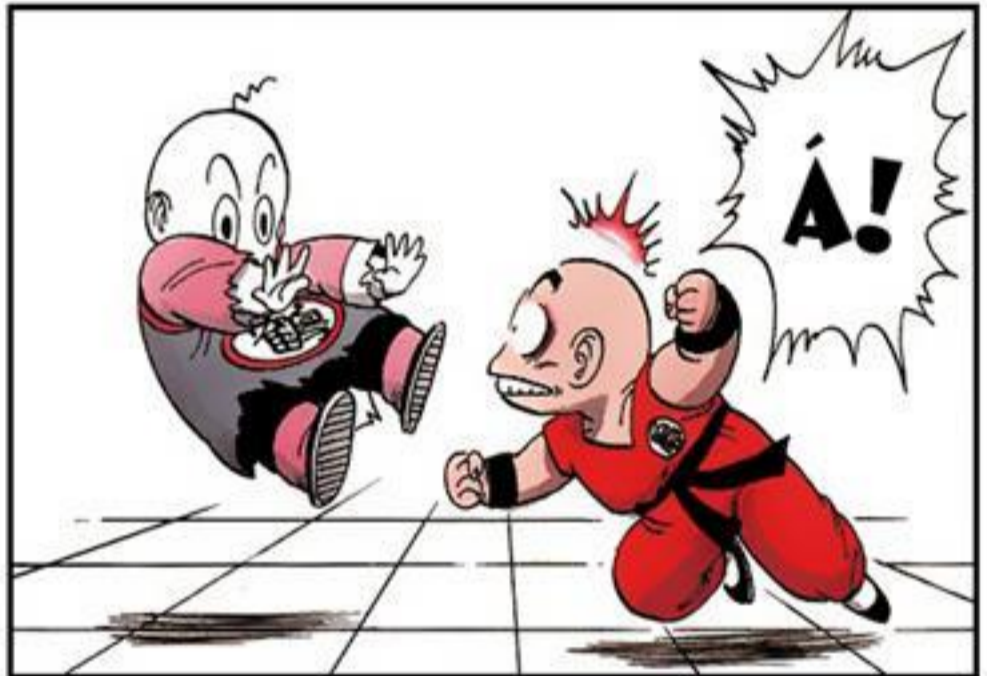

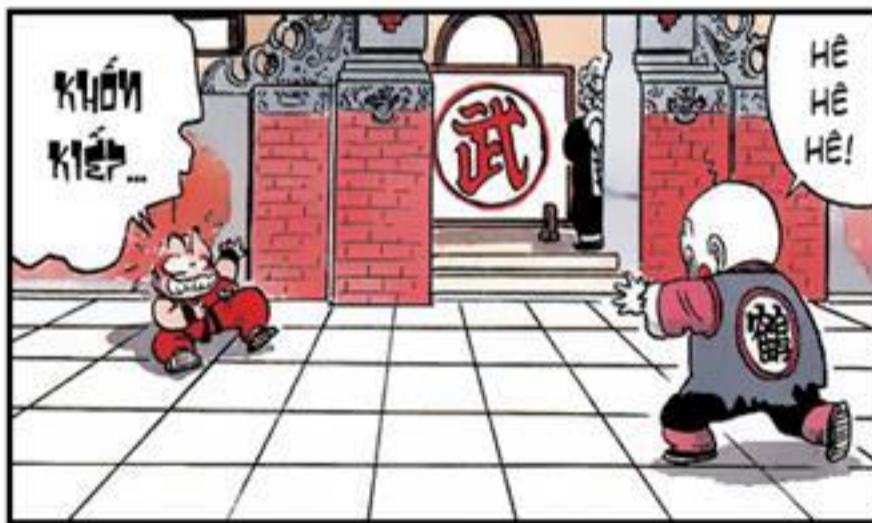

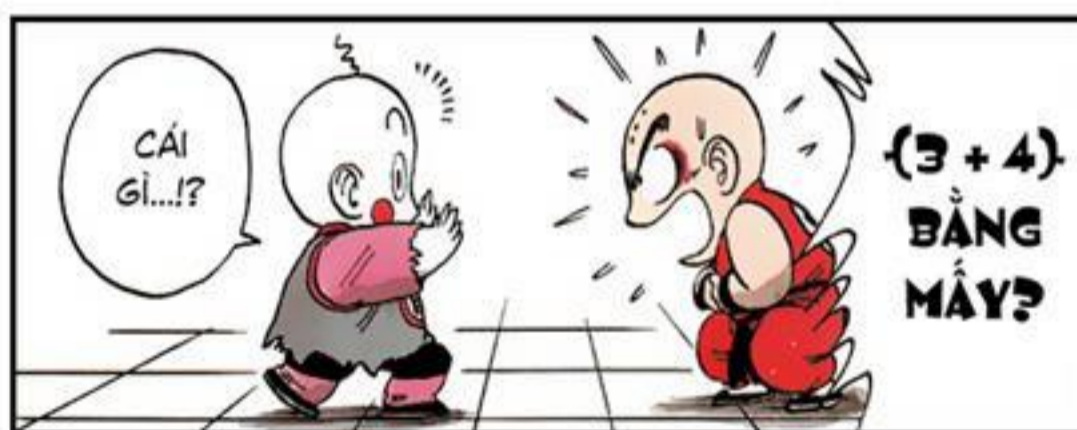
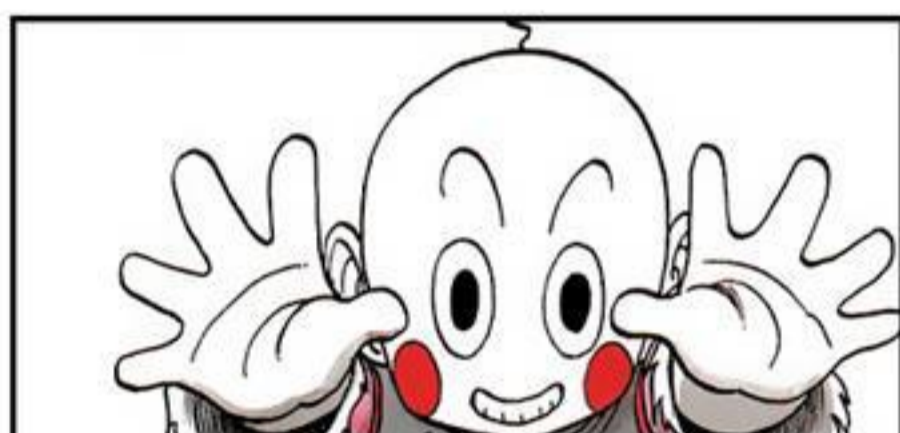

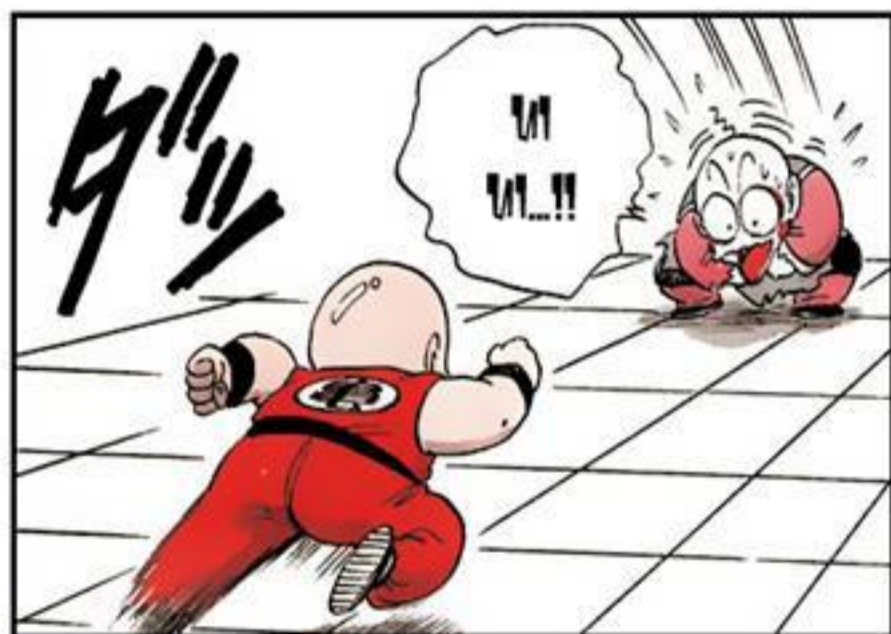

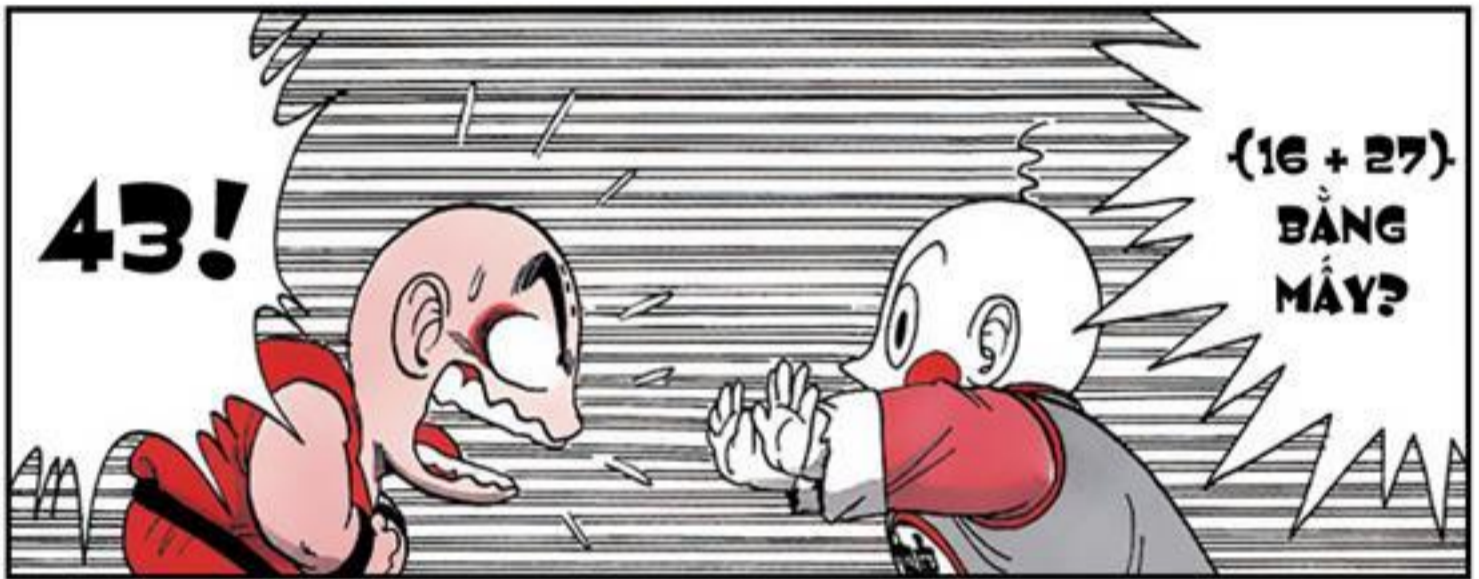



ドラゴンボール



№122 - GOKU VS. PAMPUTT



A4V  
ANDREVEET



trận đấu thứ 4 và  
cũng là trận tứ kết  
cuối cùng sẽ bắt  
đầu ngay sau đây.  
tôi xin phép được  
giới thiệu...

Trận tứ kết cuối cùng sắp  
sủa diễn ra. Rốt cuộc cũng  
tới lúc Gokuu của chúng ta  
thượng đài, cậu bé sẽ đối  
phó như thế nào với đối thủ  
chưa từng biết mặt đây?







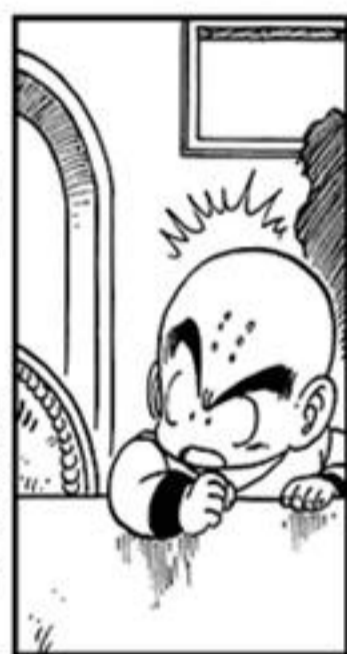

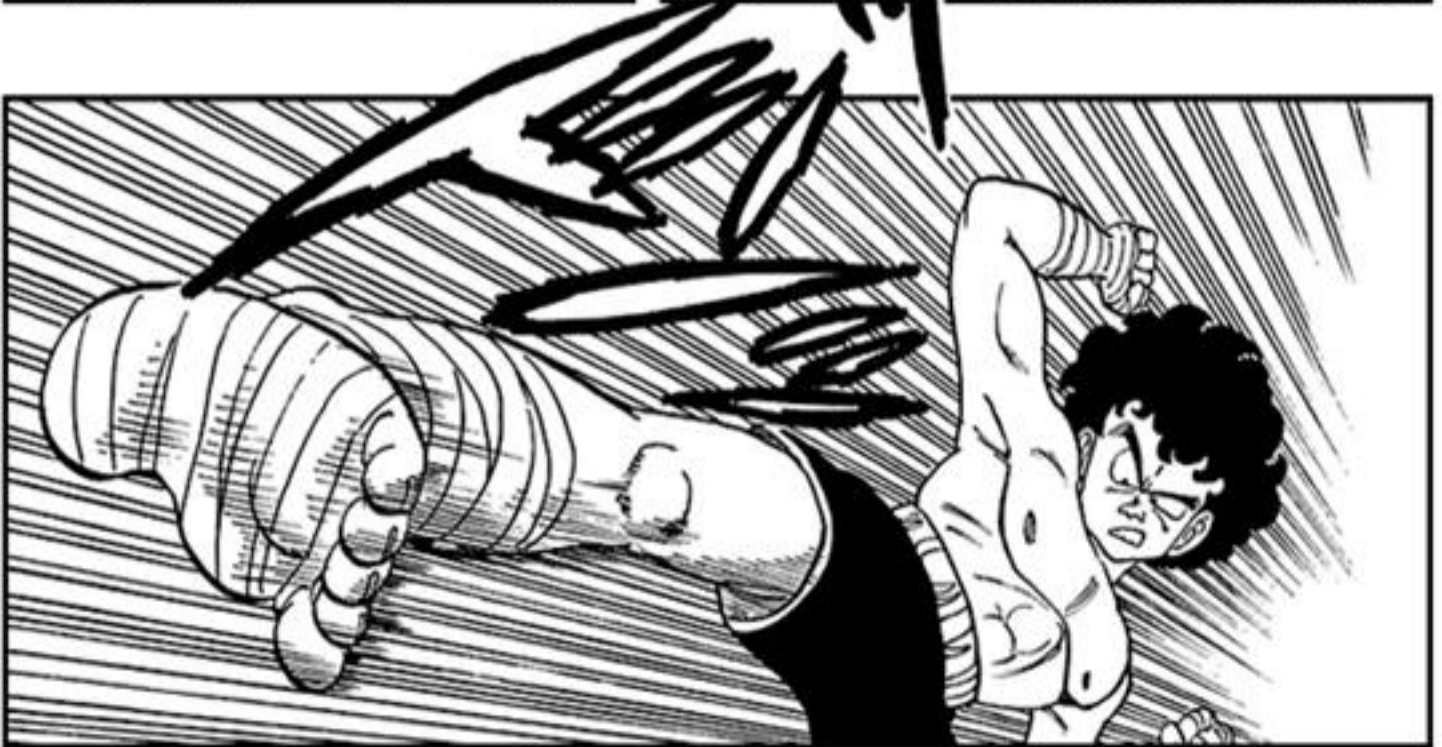



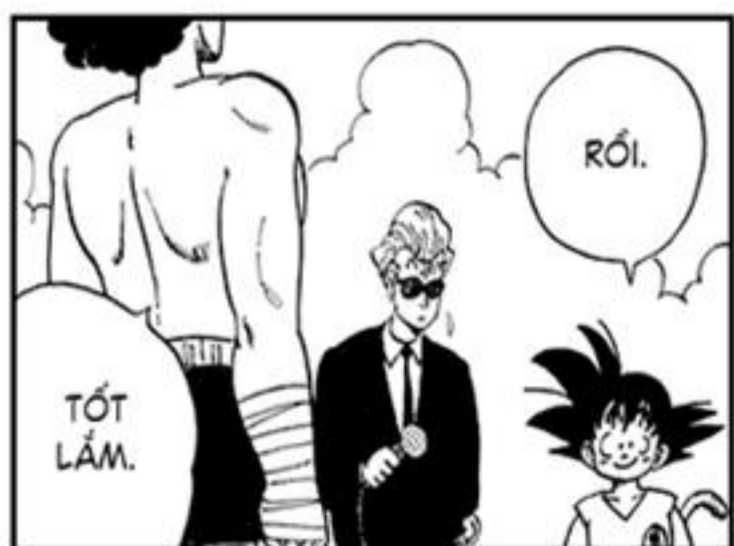
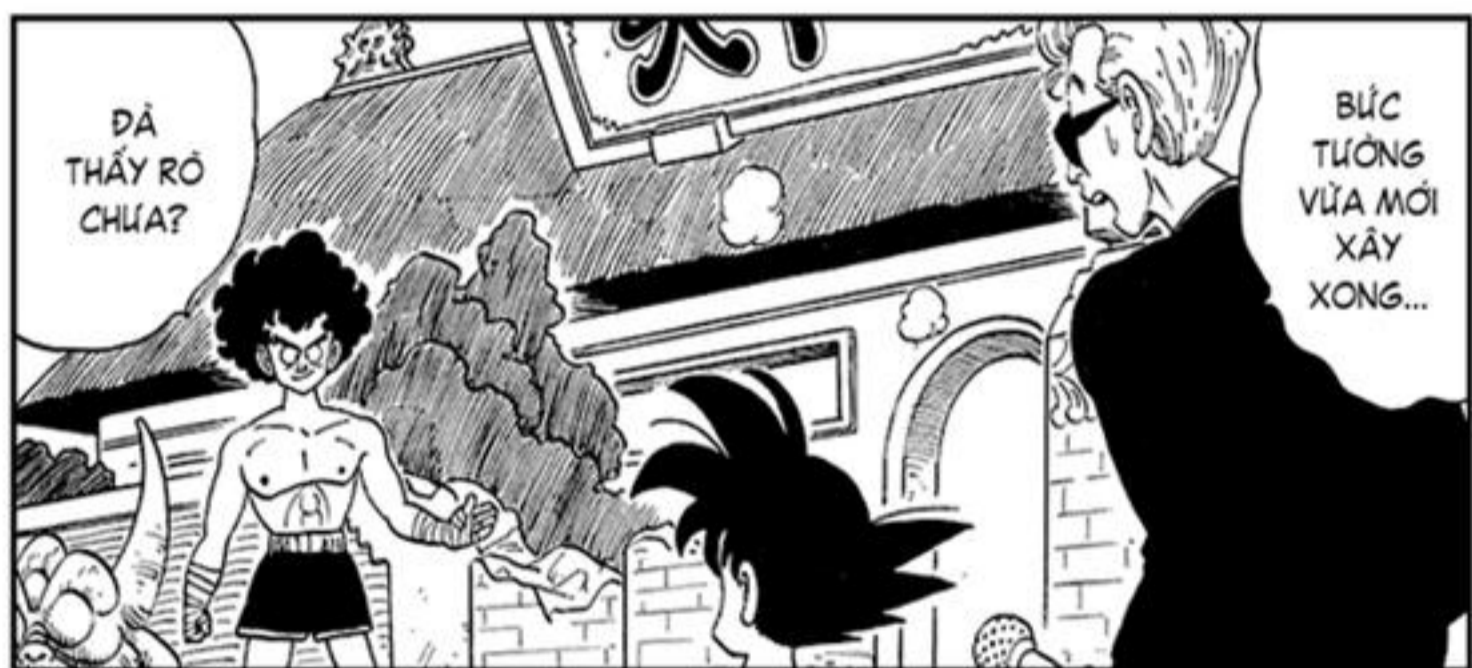







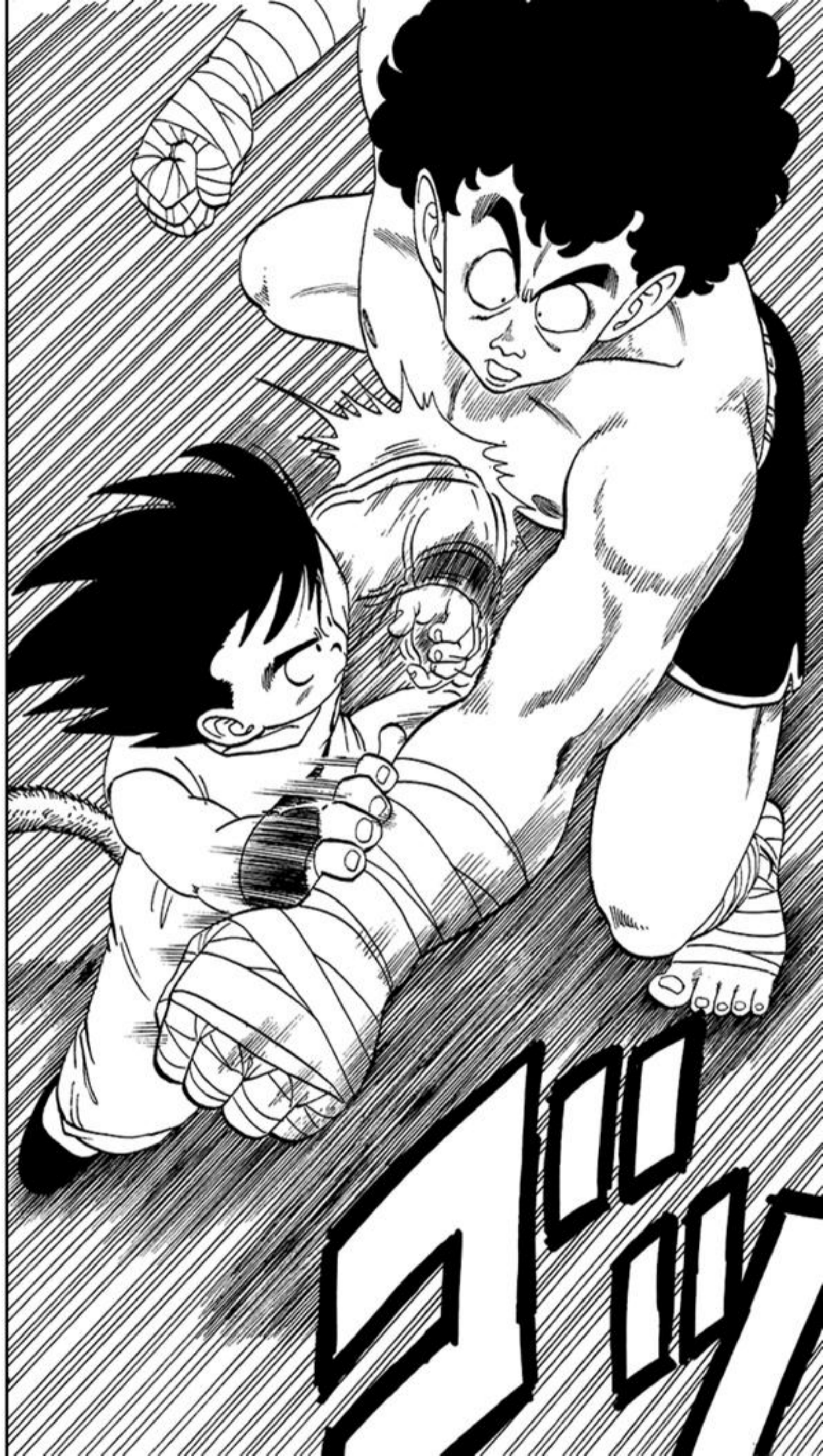







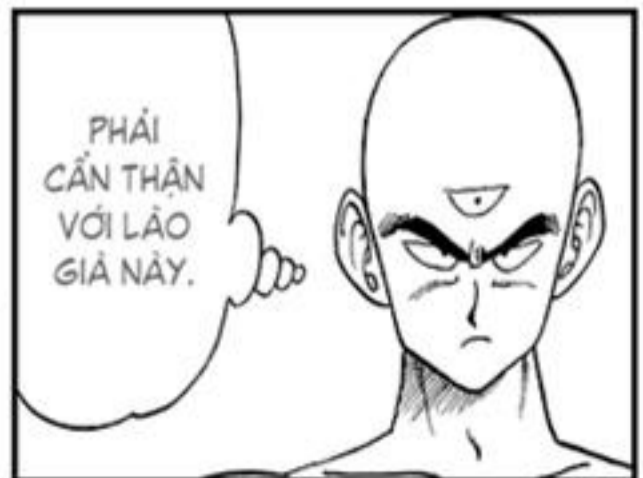
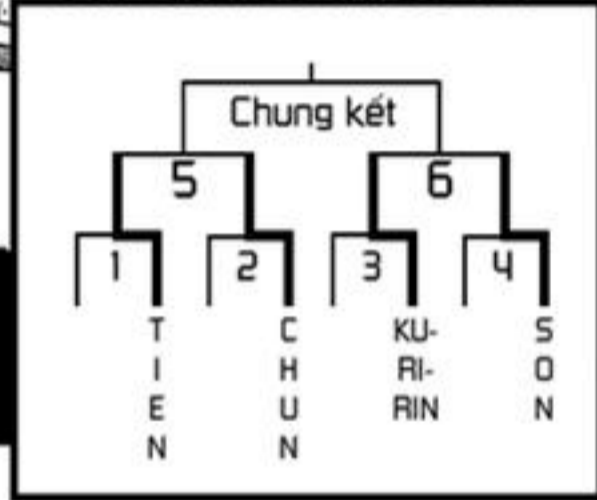

ドラゴンボール

# DRAGON BALL

№123 - TIEN SHINHAN VS. JACKIE CHUN





... TRÌNH  
ĐỘ LÃO  
TA THỂ  
NÀO.

ĐỂ  
XEM  
...



bắt  
đầu!

hai  
vị sẵn  
sàng  
chưa?



JACKIE SẼ  
TRẢ THÙ CHO  
YAMUCHA!

HÈ HÈ!  
THẮNG ĐÓ  
XUI RỒI!



HÁ?

CHƯA  
CHẮC DẦU...



và bây giờ là  
trận bán kết đầu  
tiên! Jackie Chun  
chính là đương kim  
vô địch. chúng ta  
hãy xem...

... liệu đối  
thủ trẻ tuổi,  
Tien, có làm  
nên điều gì  
điều gì  
không!

ỪM...



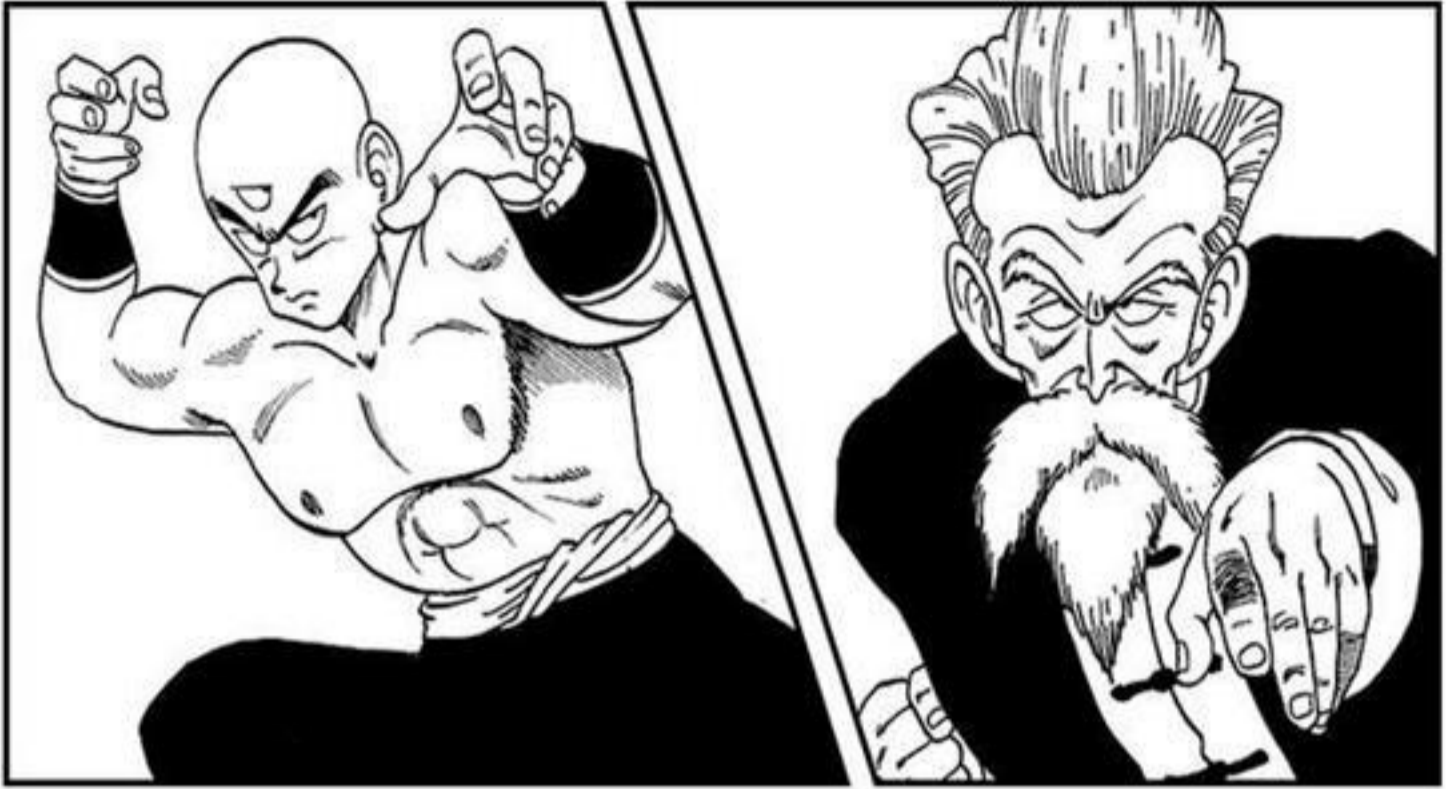



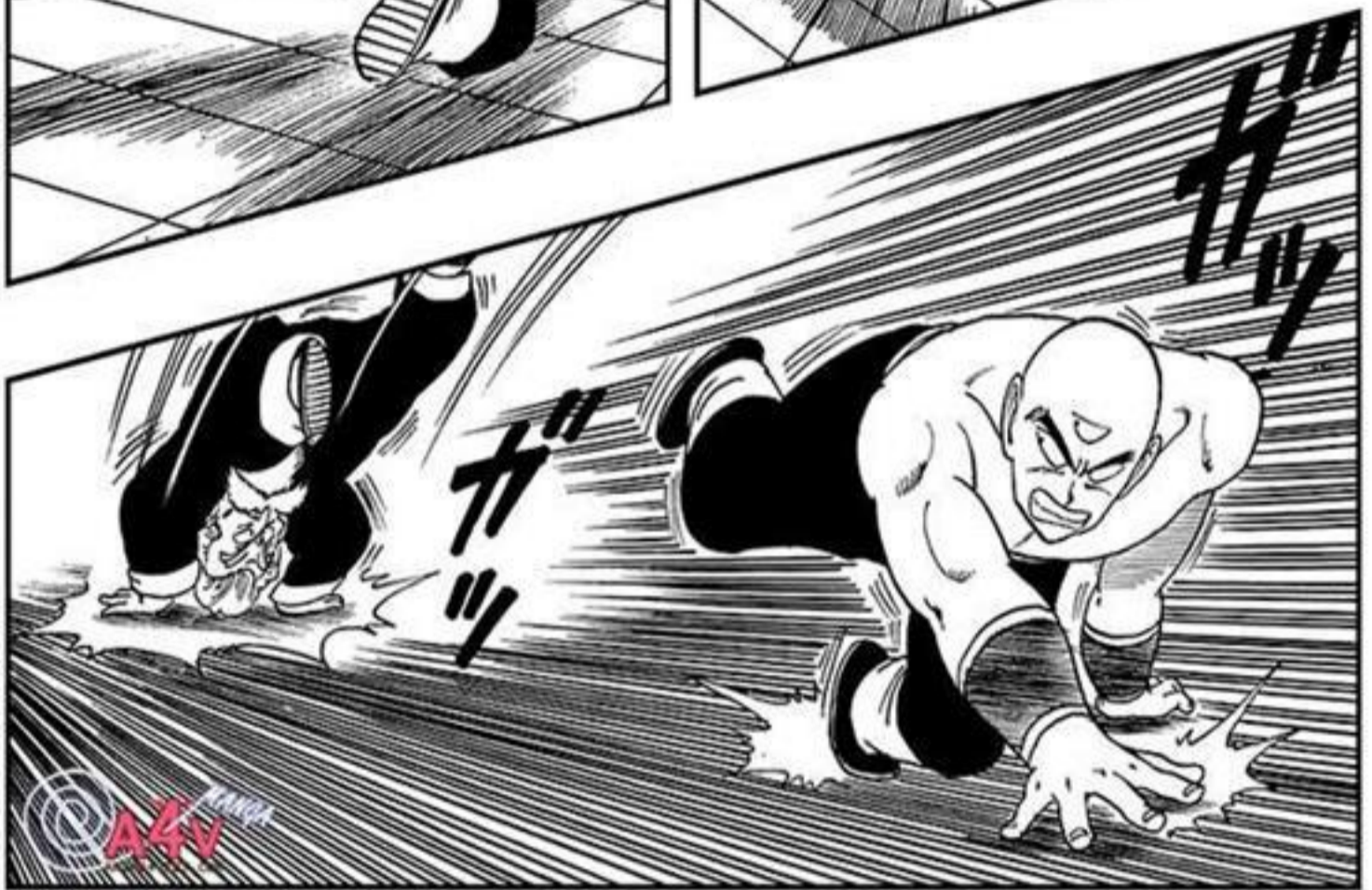



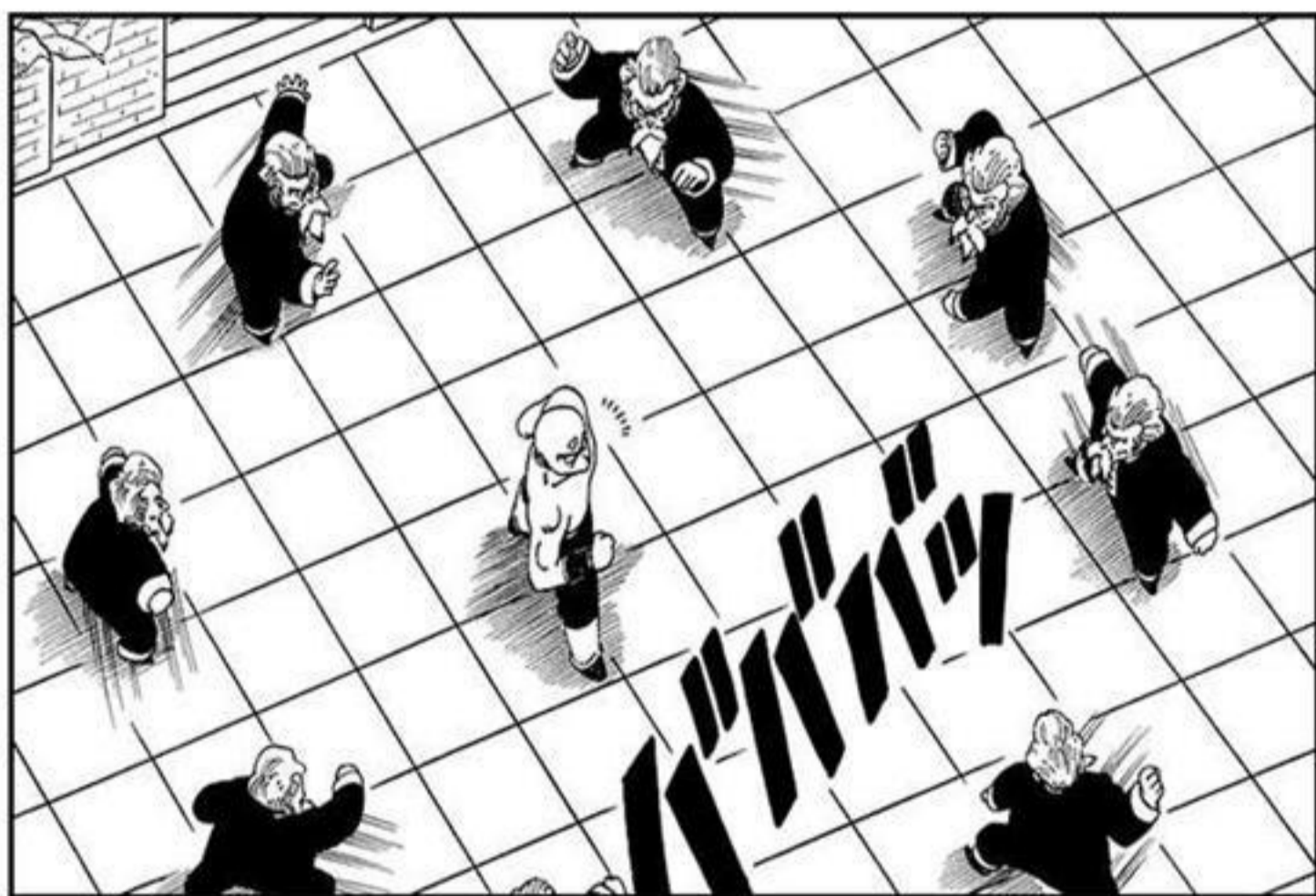











... LÃO GIÀ ĐANG CHẾT!















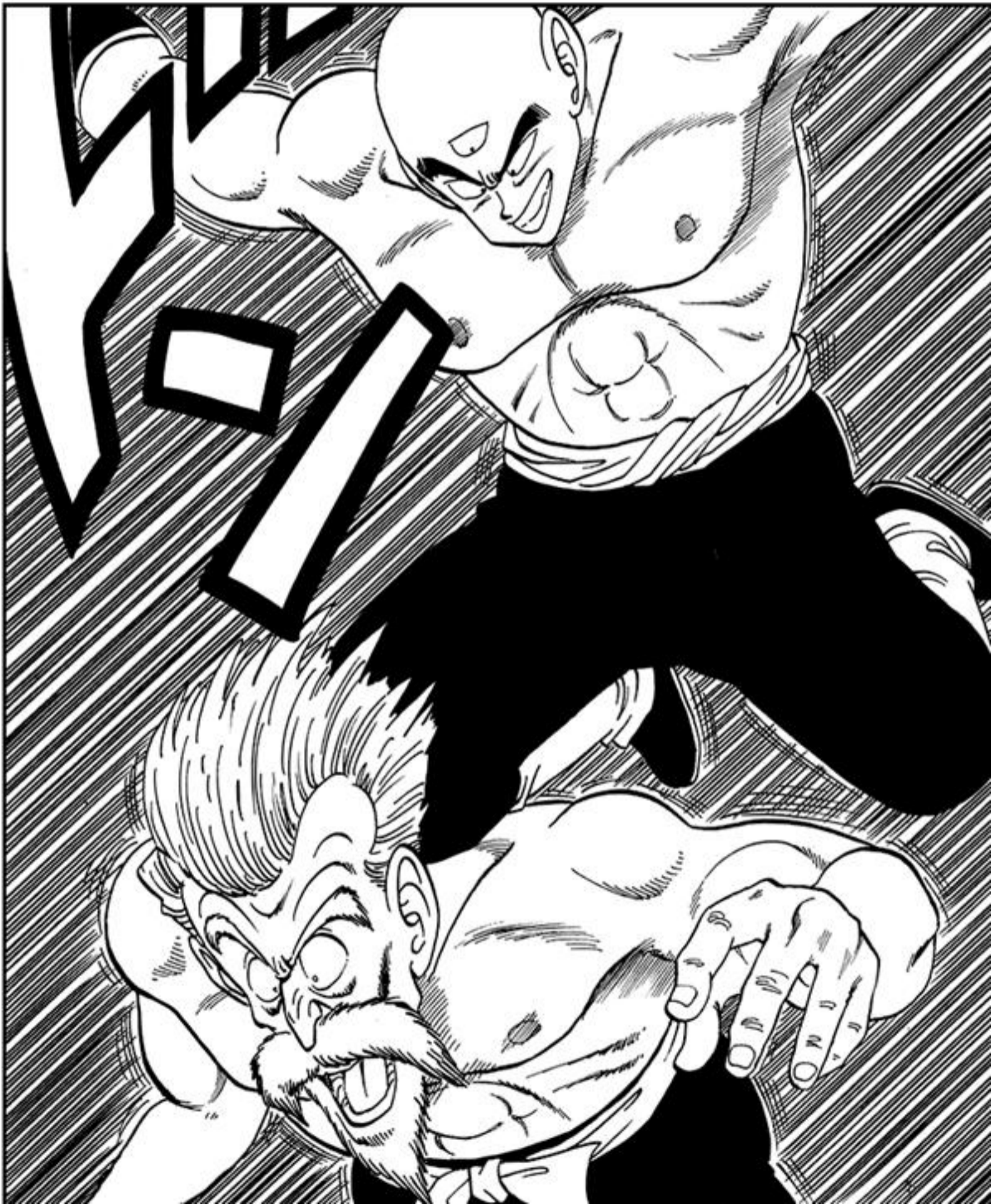





CHUYỆN  
GÌ XẢY  
RA VẬY  
!?



CHỈ CẦN  
LÀM LÃO  
HƠN MÈ LÀ  
ĐỦ RỒI.

TA KHÔNG  
THÊM GIẾT  
LÃO ĐÀU.  
NẾU KHÔNG  
TA SẼ BỊ  
PHÁN THUA  
CHUỘC.



JACKIE!  
ĐỪNG  
LÊN ĐI!

tôi bắt  
đầu đếm!  
một! hai!  
ba!



sau khi khiến  
Jackie Chun mất  
khả năng nhìn,  
Tien đã tung một  
đòn vào cổ đối  
thủ!

thật  
đáng  
sợ!



UI DA  
...!

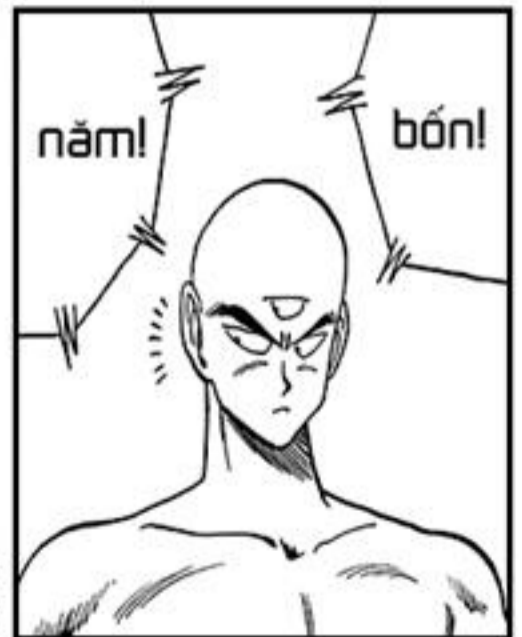

năm!

bốn!





TỰ MÀ  
GIỮ CÀI  
BÀI GIẢNG  
NGU NGỐC  
ĐÓ CHO  
MÌNH ĐI!

LÃO  
ĐIÊN  
!!



NẾU  
CHIẾN  
ĐẦU VÌ LỄ  
PHẢI...

NGƯỜI  
CHẰNG  
BAO GIỜ  
THUA  
ĐƯỢC!



CÓ  
GÌ SAI  
SAO?

SAO THẾ?  
NÓI GIẬN  
RỒI À?





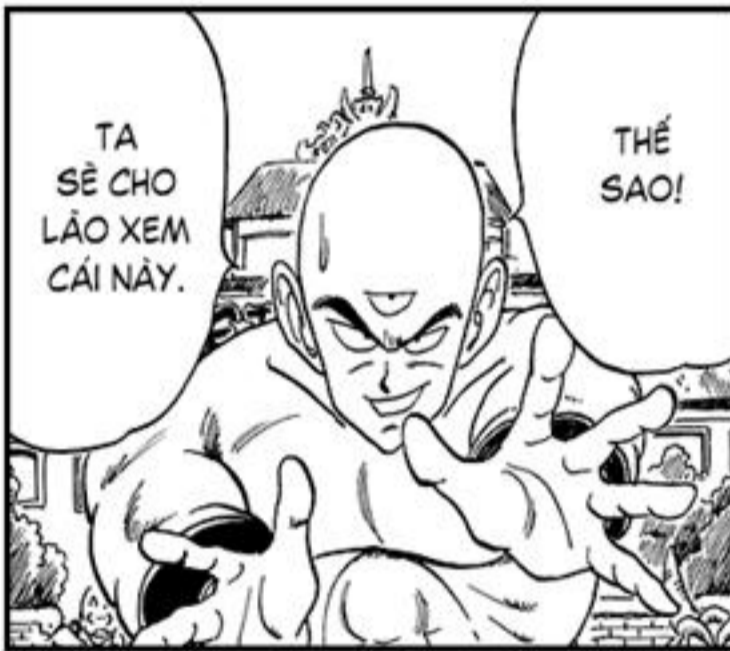





NHƯ THẾ  
SẼ ĐÁNH  
VÀO  
KHÁN  
GIẢ PHÍA  
SAU TA!

NÓ  
ĐIÊN  
RỒI!



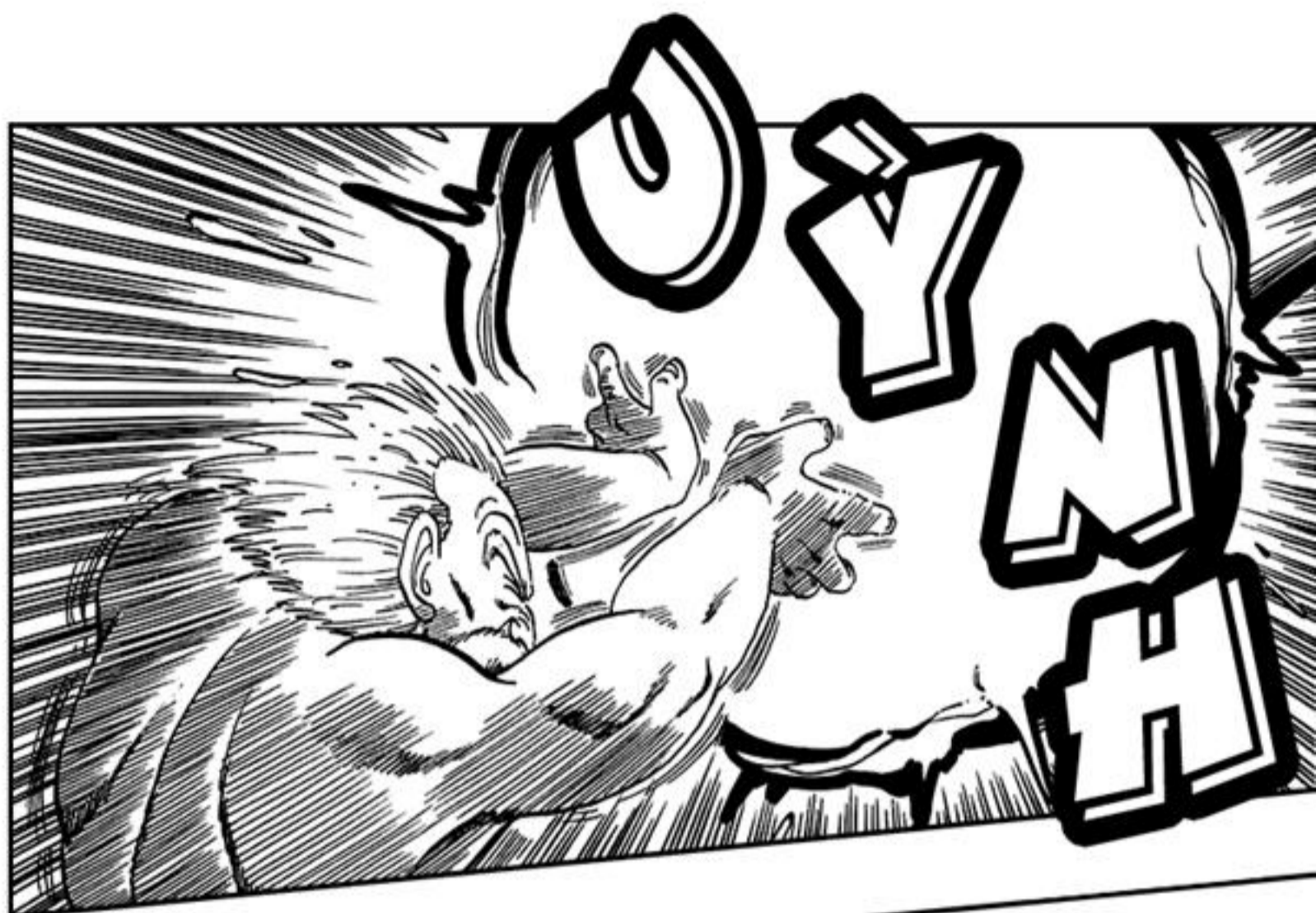







HÈ!

Chun đã rơi khỏi võ đài!



SAO LẠI THẾ!?



CÁI GÌ!?



LÃO TA KHÔNG CHỊU ĐỐI MẶT VỚI HIỆN THỰC! THẬT LÀ HÈ NHẤT!



SAO ÔNG LẠI CHỊU THUA!?

LALA-LALA-LA-LA-LALA...



ÔNG TA CHƯA TUNG HẾT SỨC!

HỦ...



TRẬN TIẾP LÀ CỦA HAI NHÓC ĐÂY.

...

ドラゴンボール



№125 - GOKU VS. KURIRIN PART.1



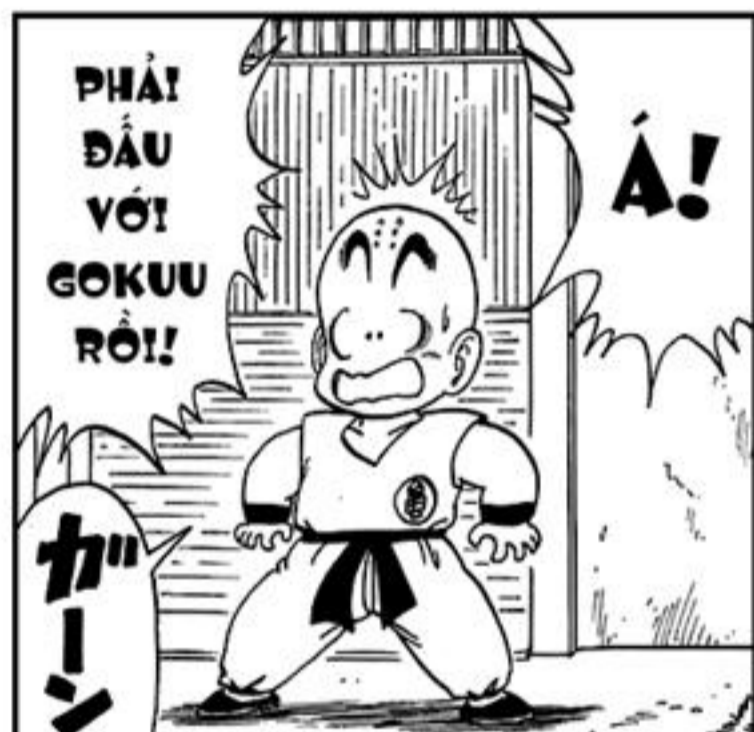
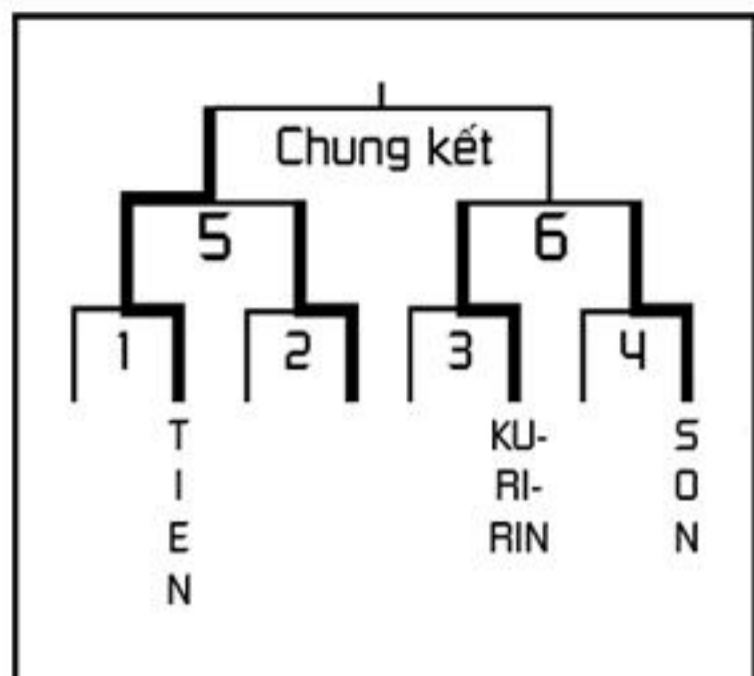





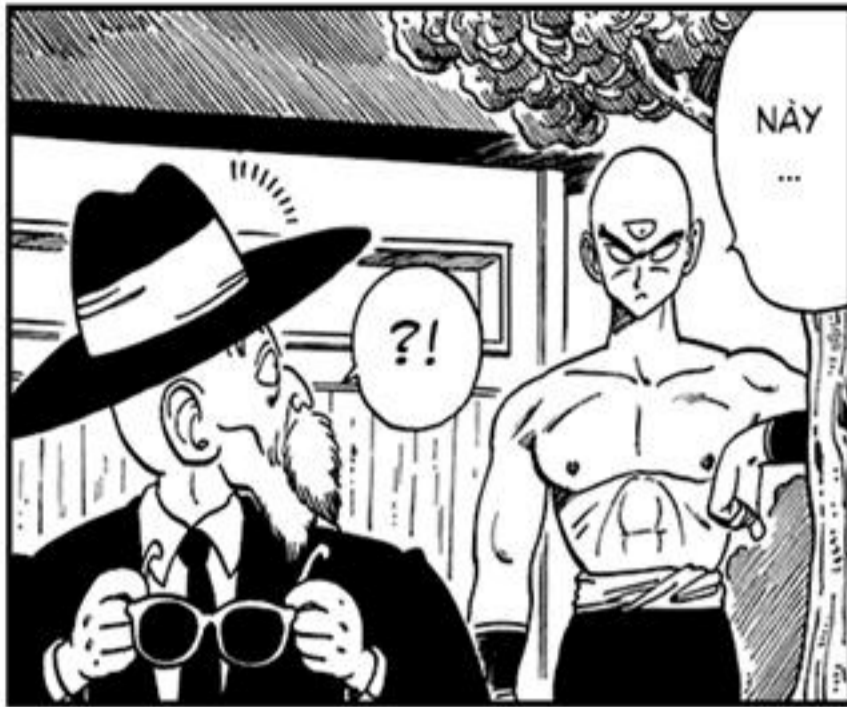

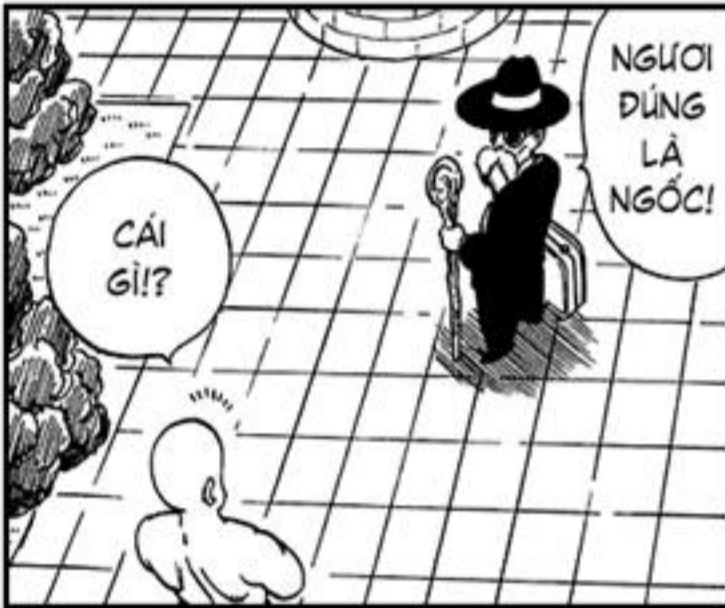



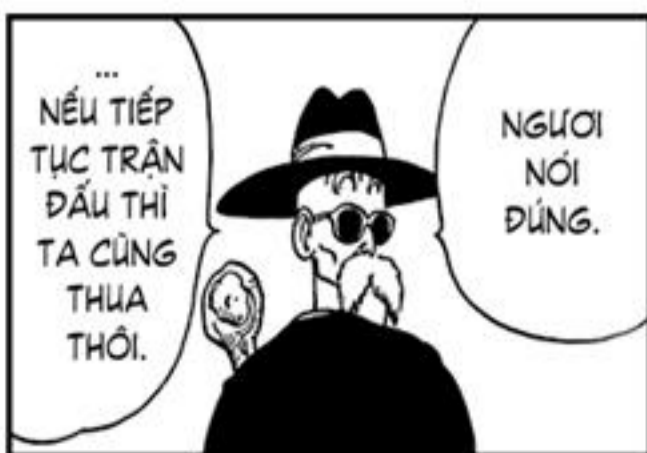



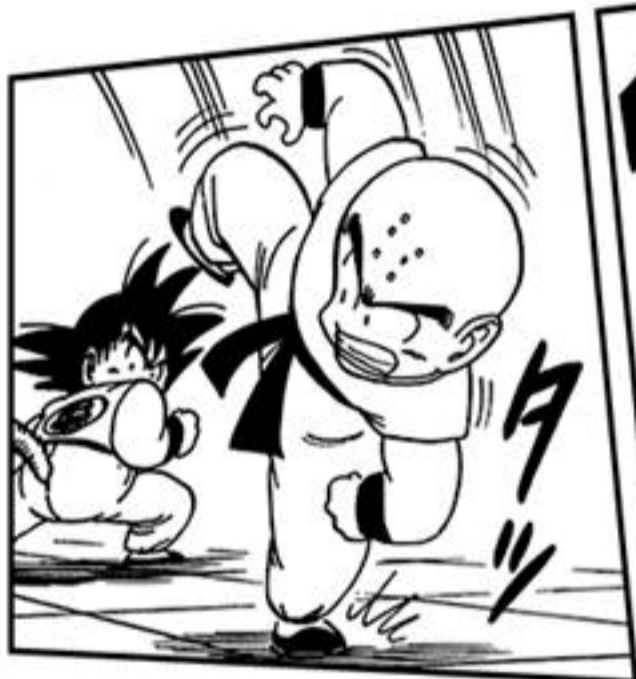
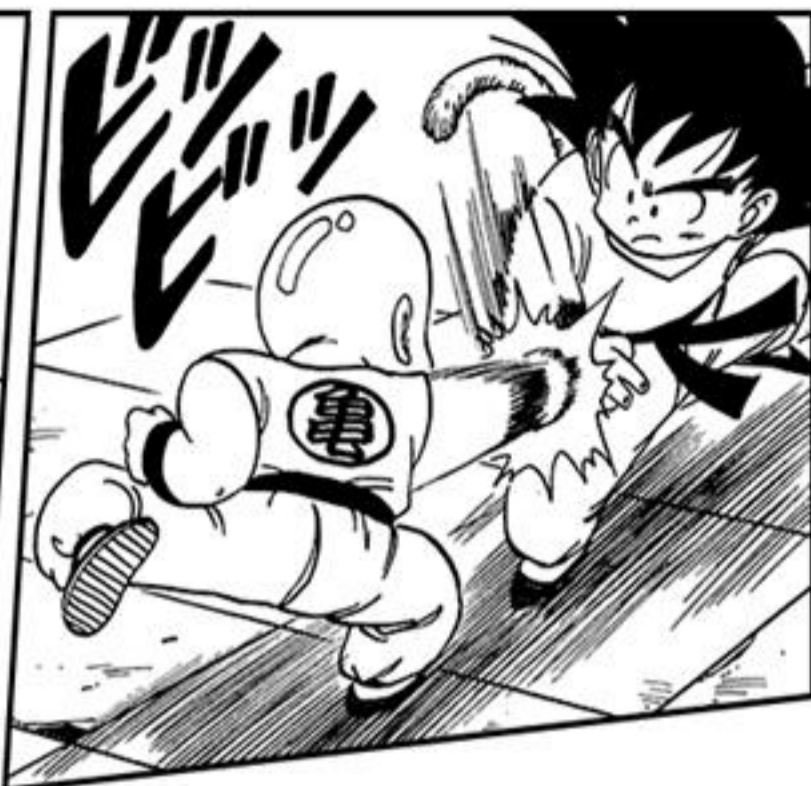

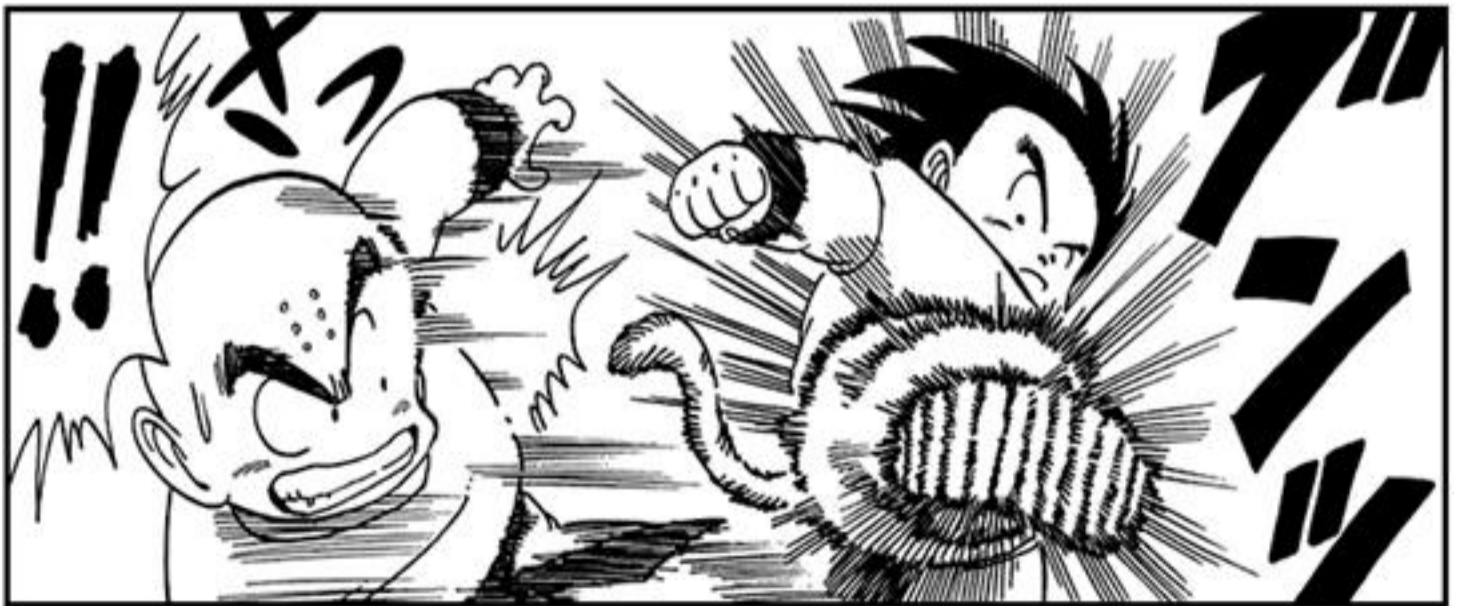
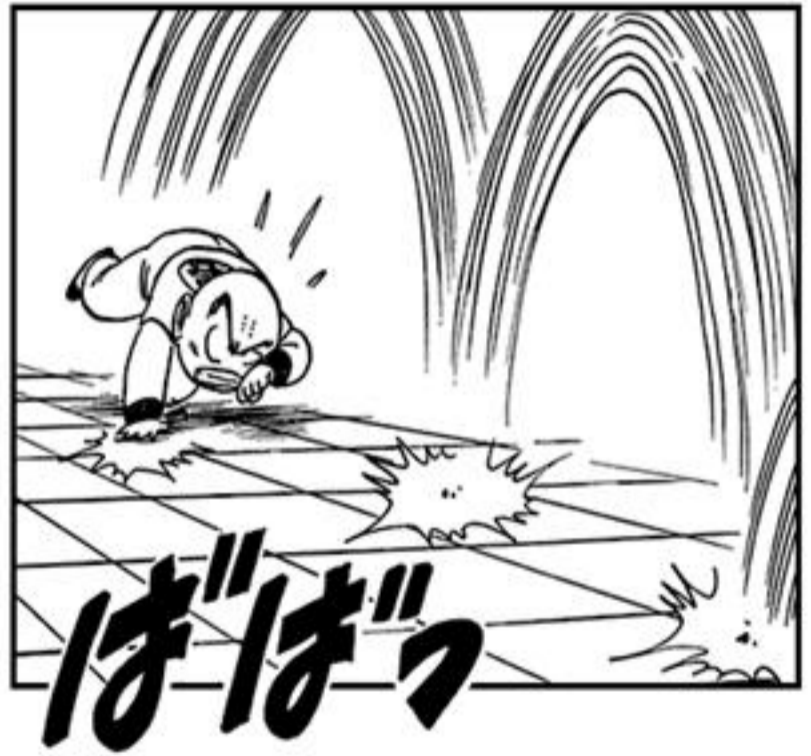

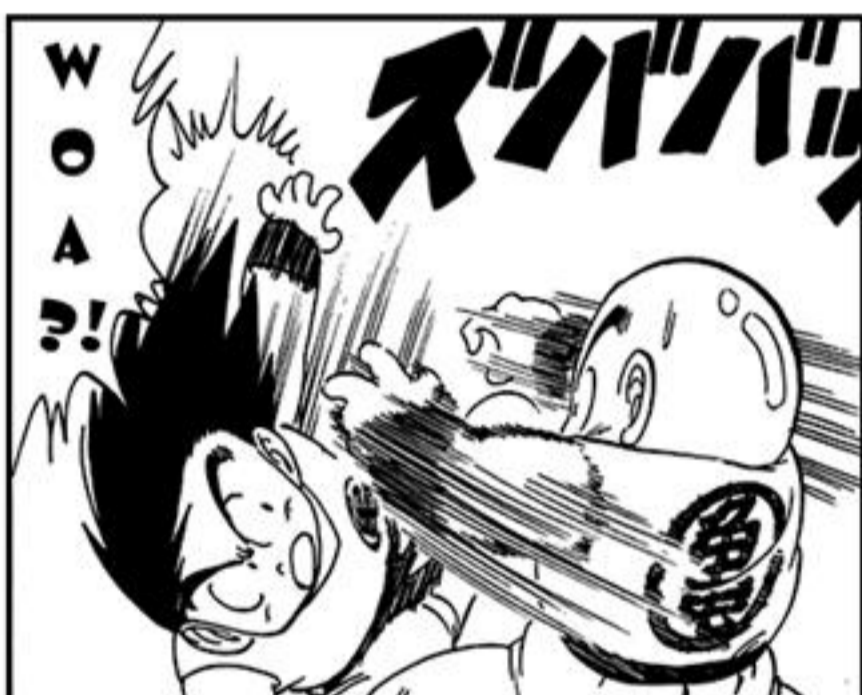

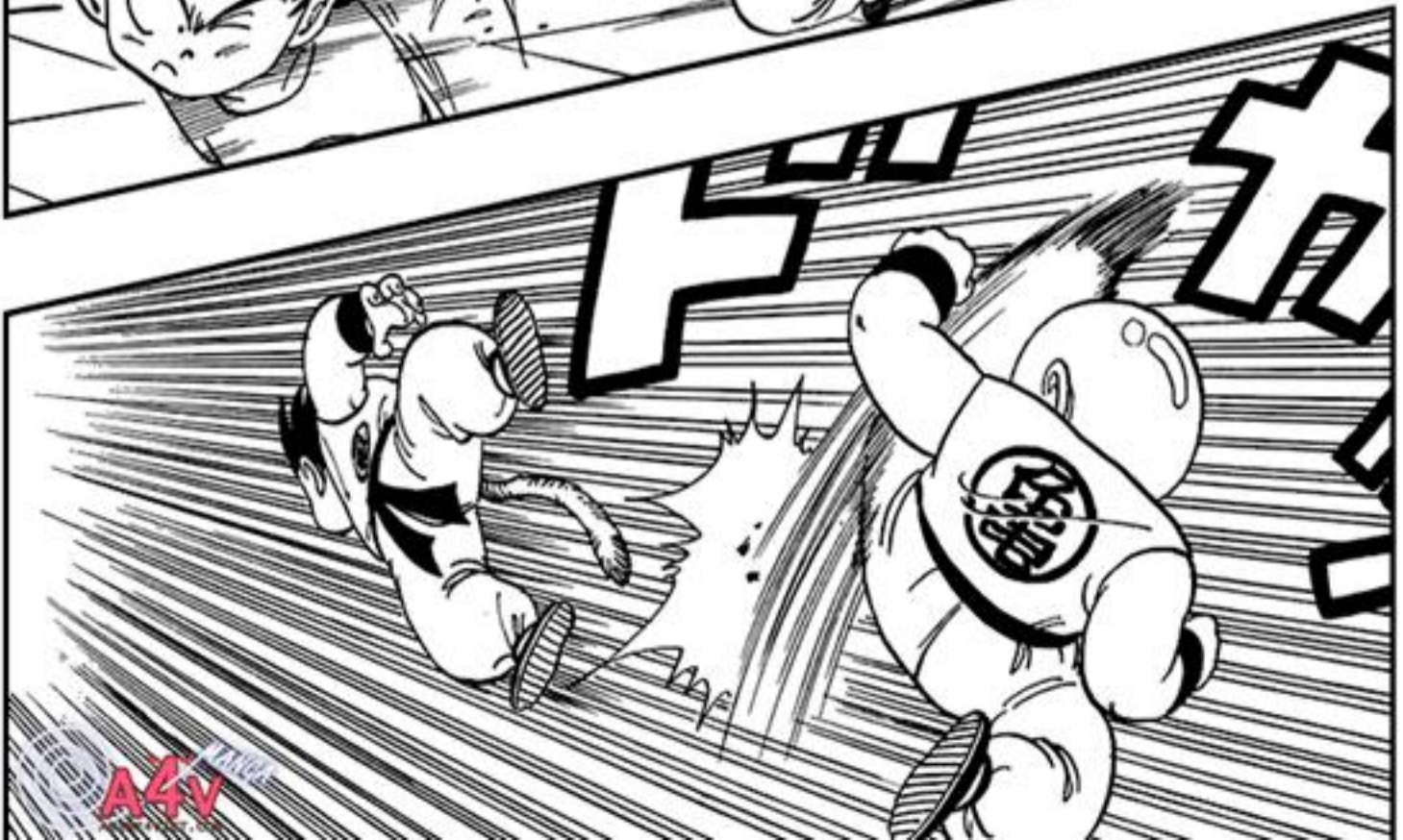
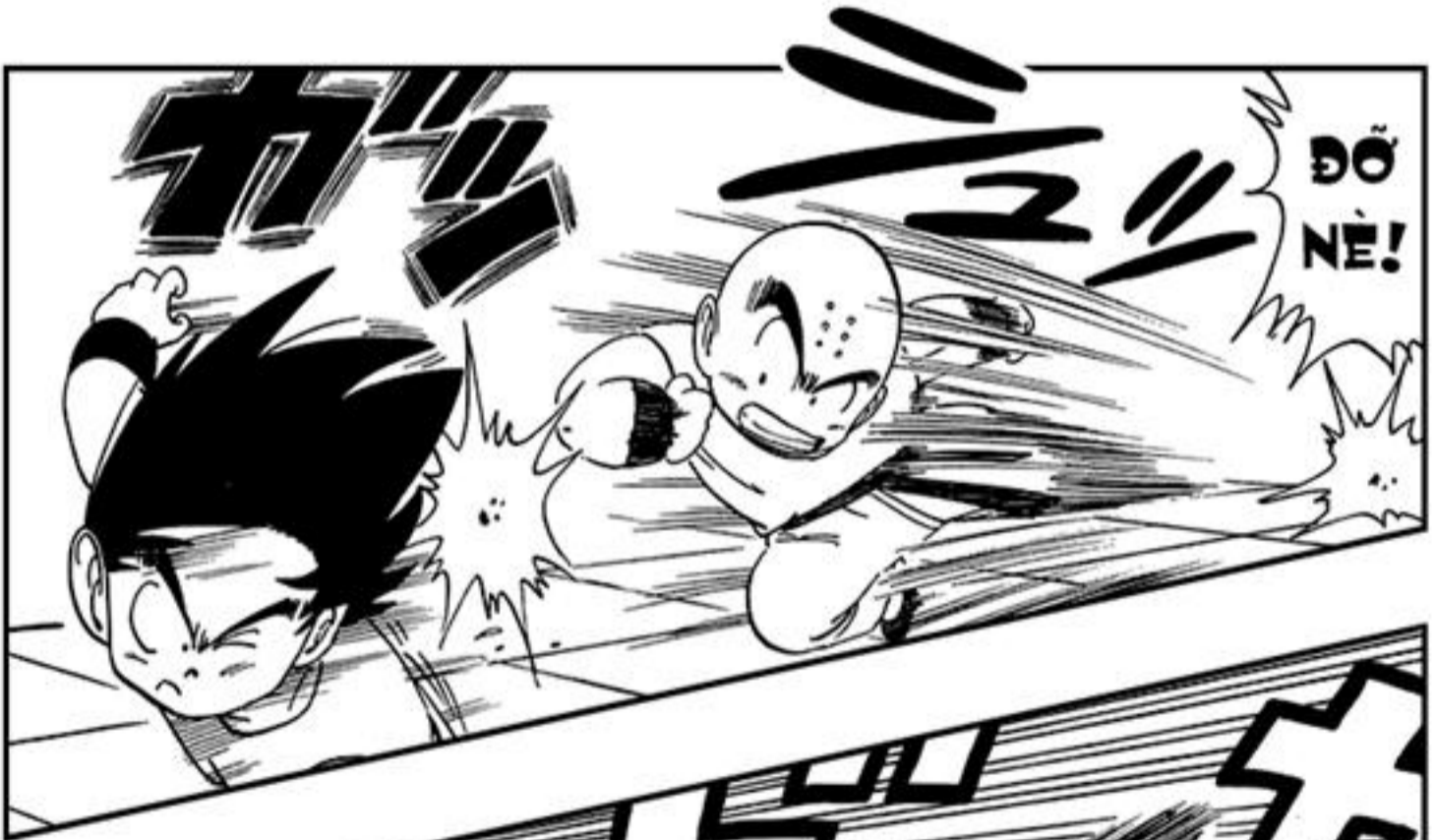



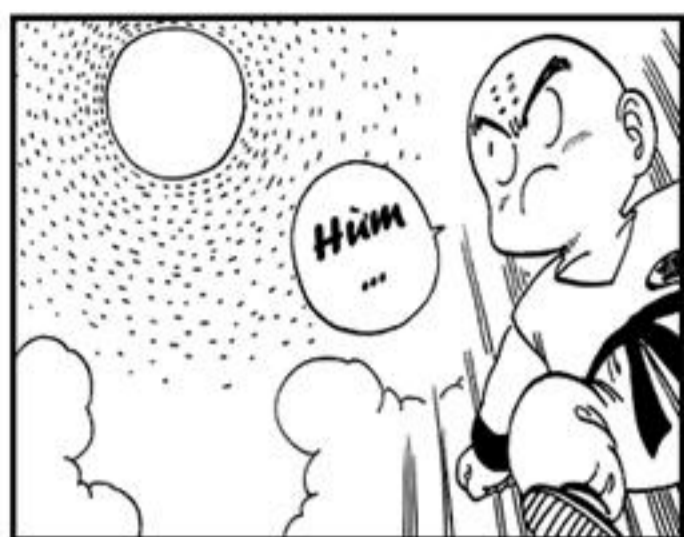



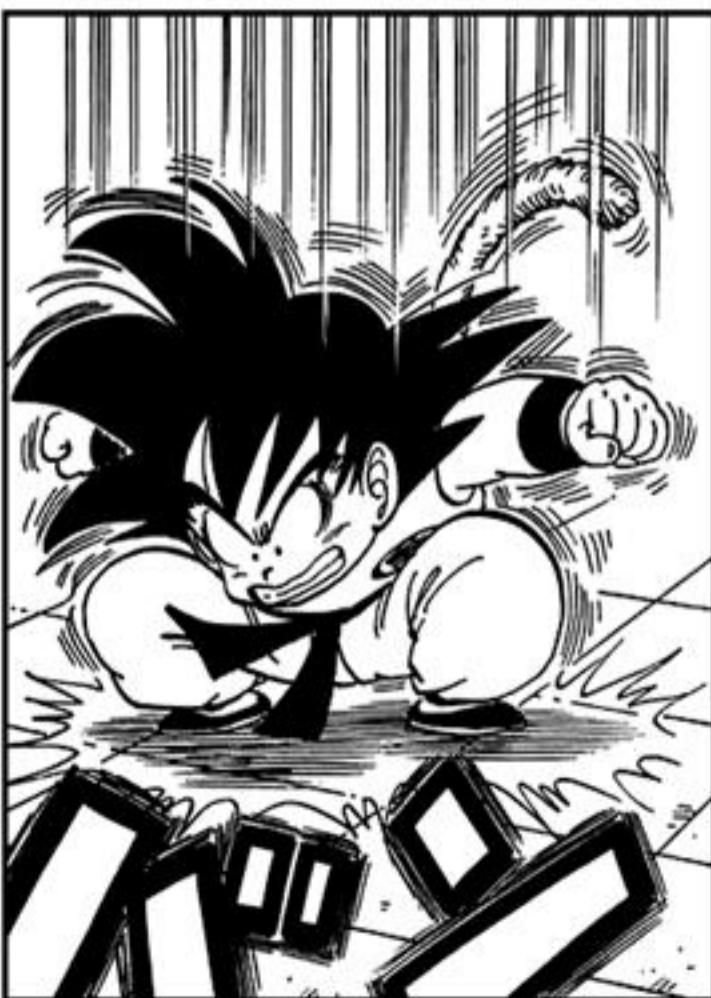
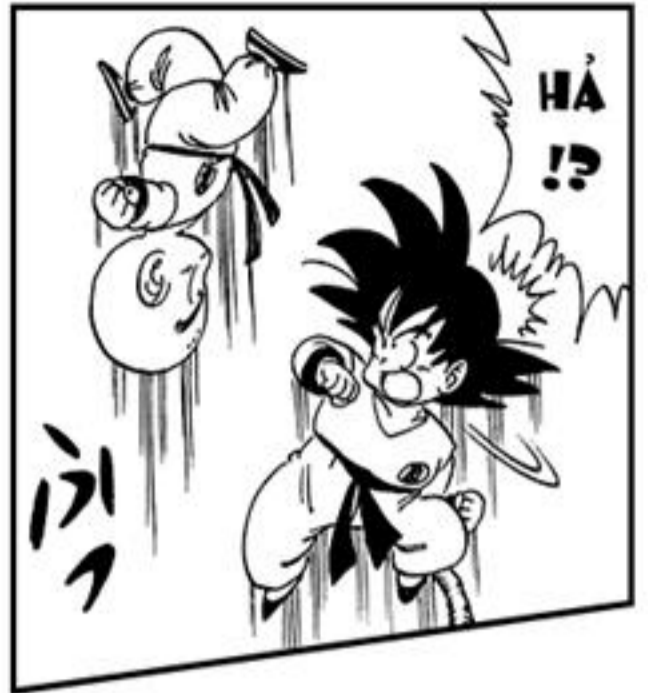







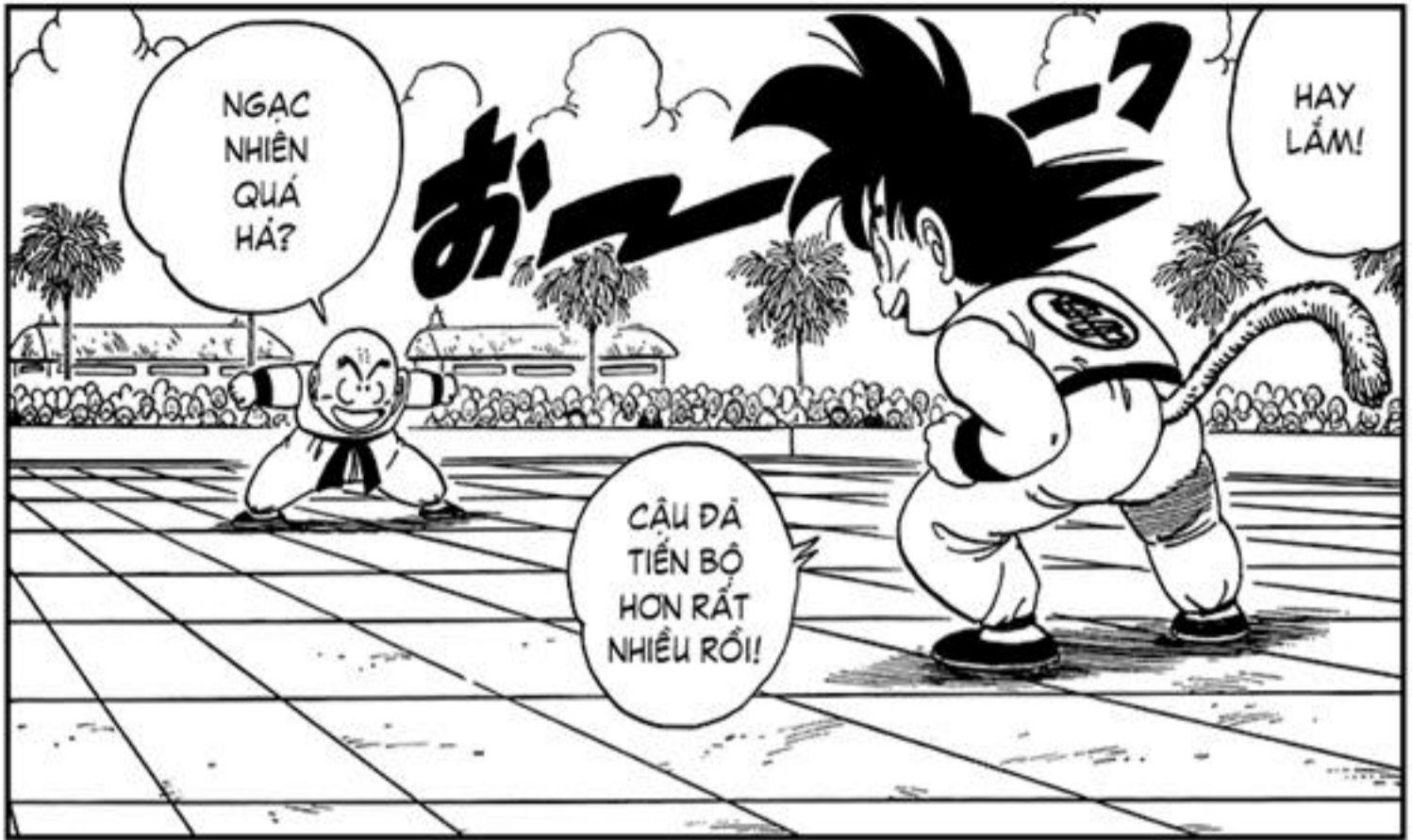

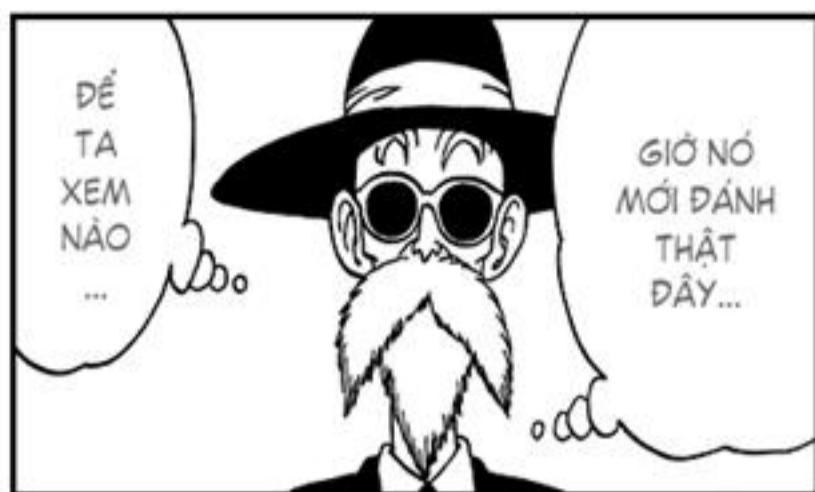

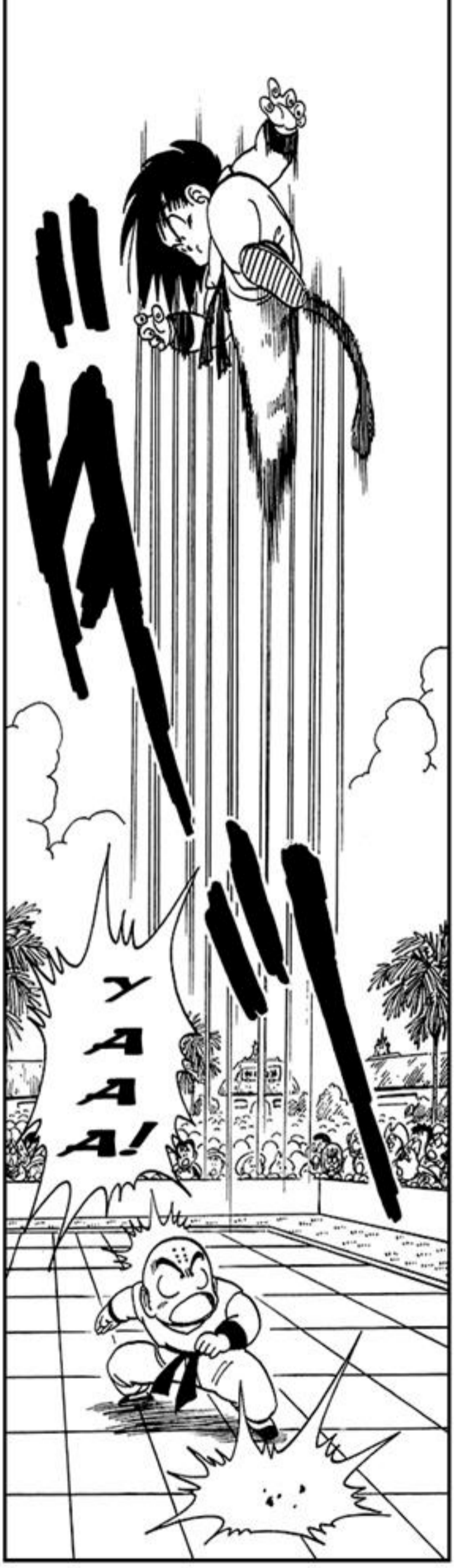





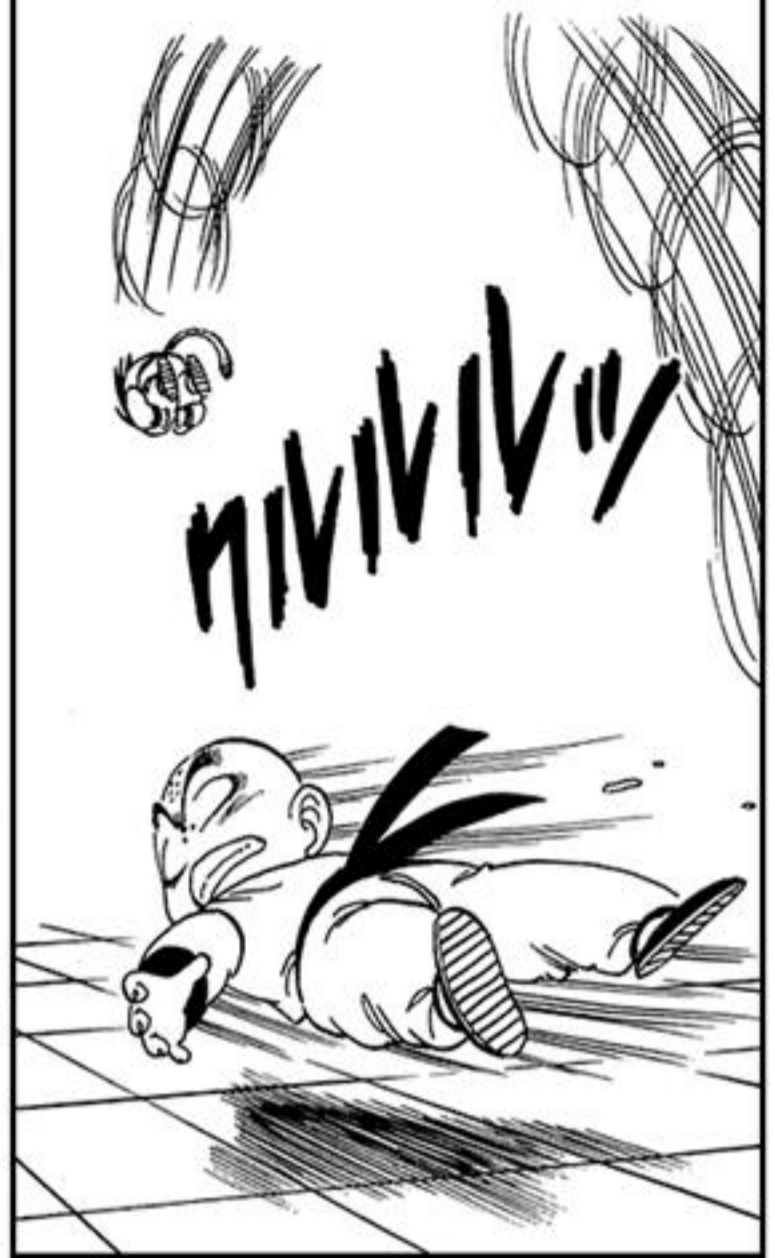

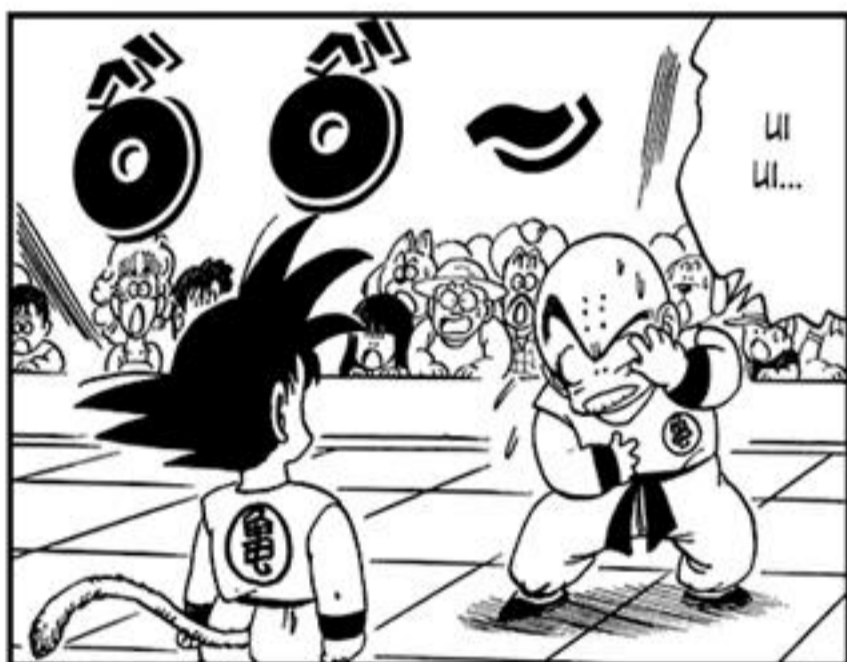

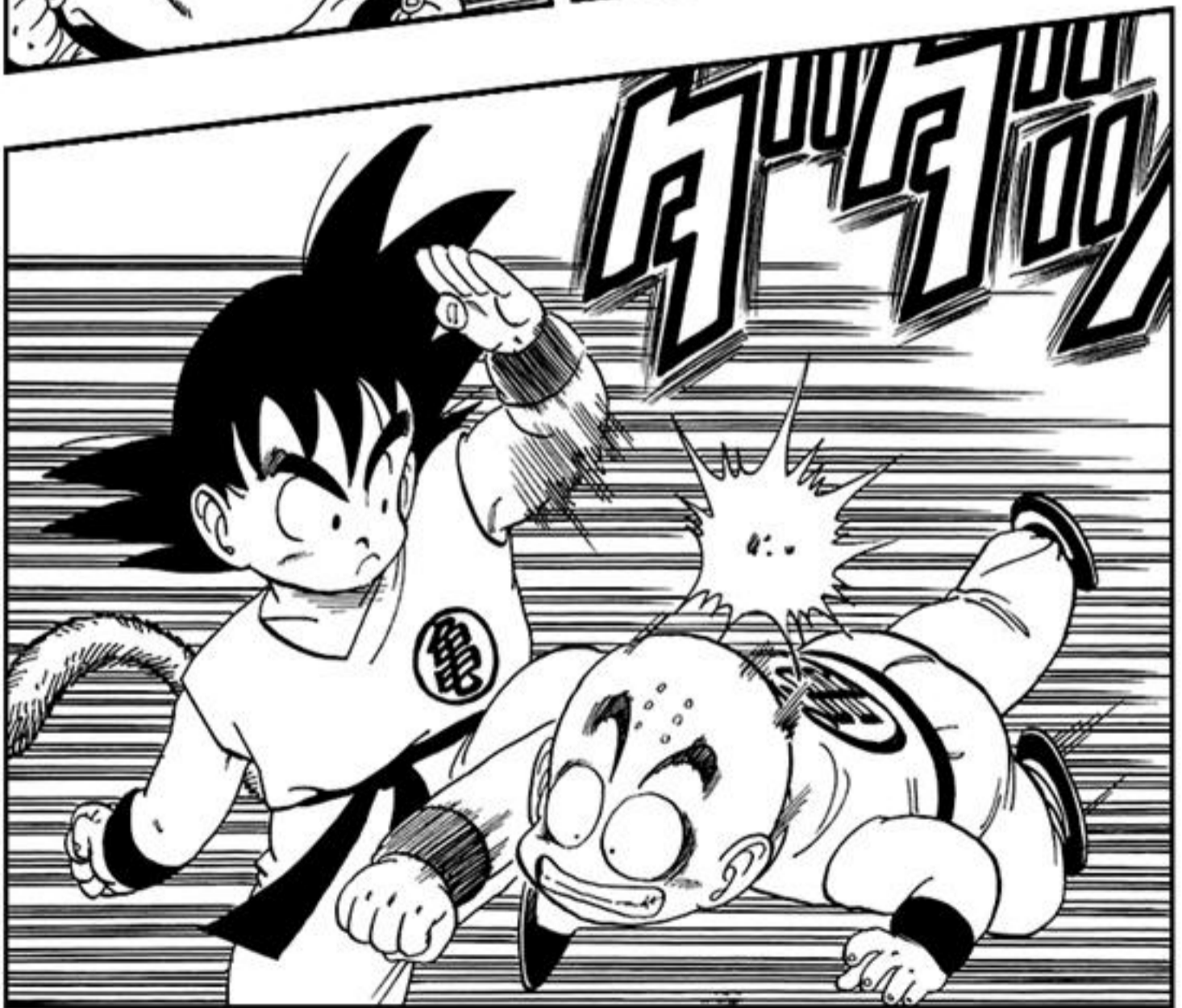

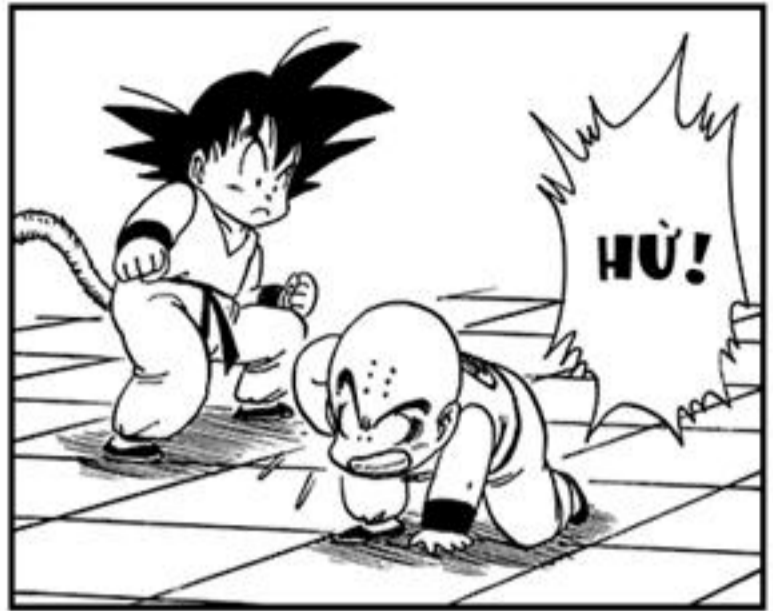

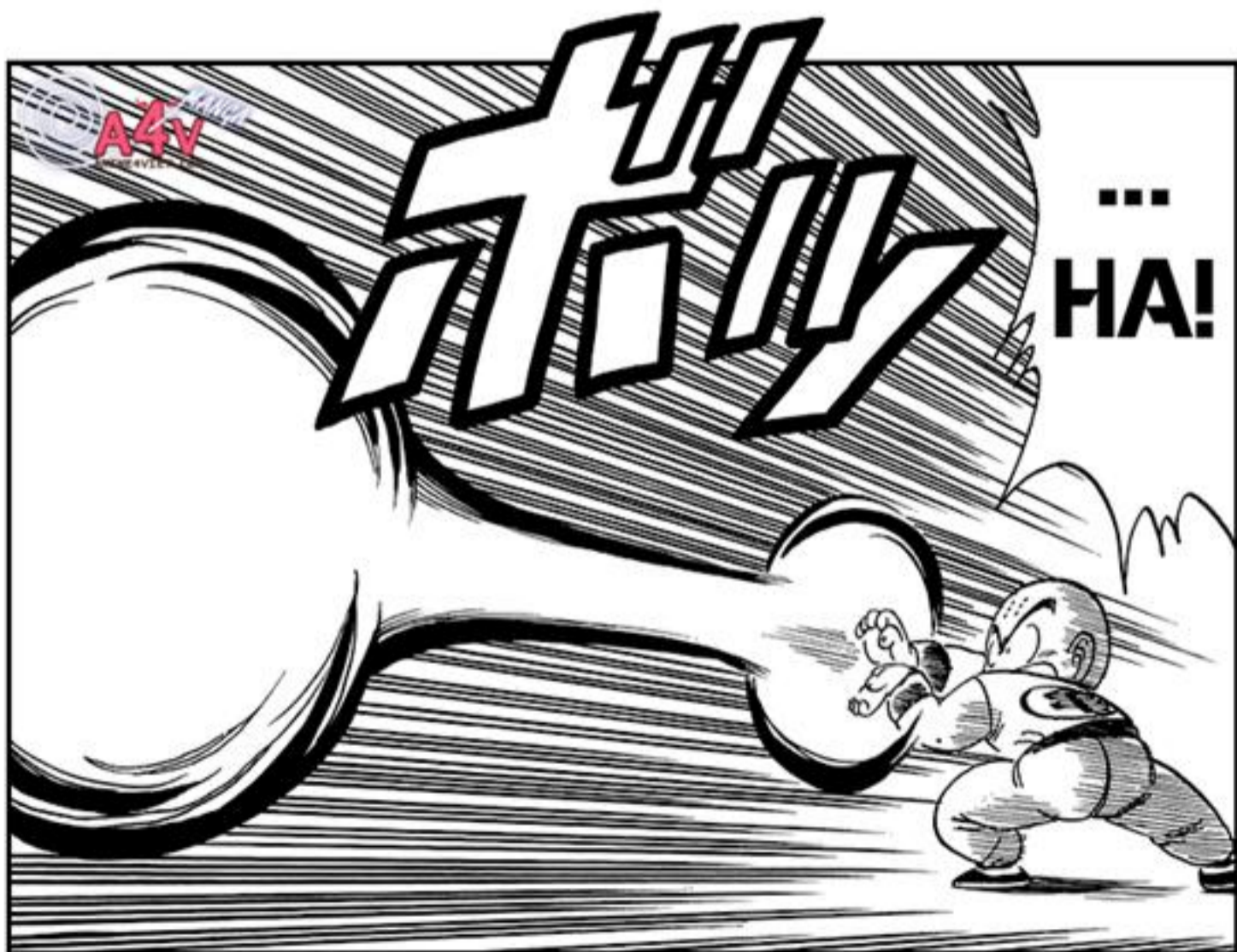



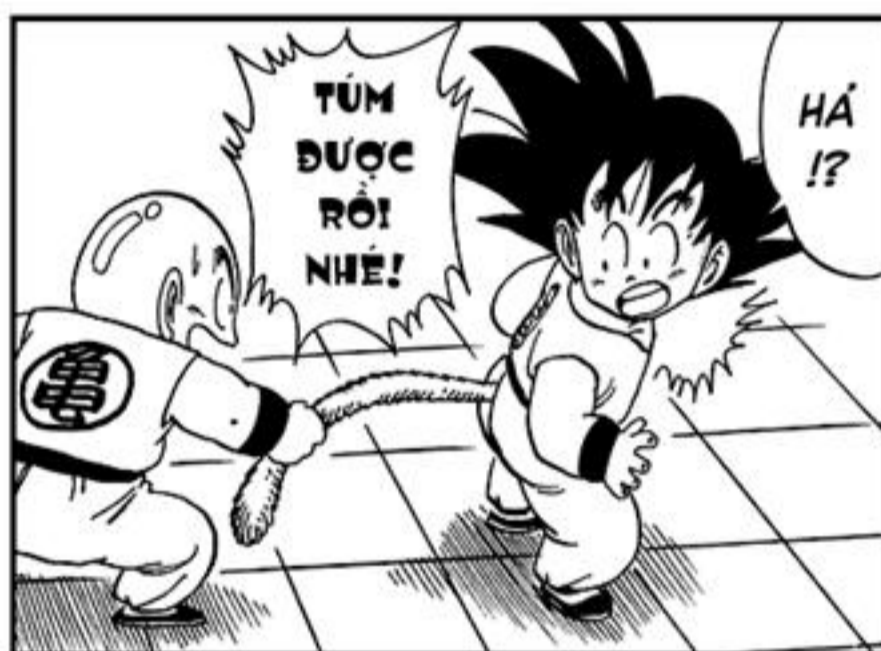

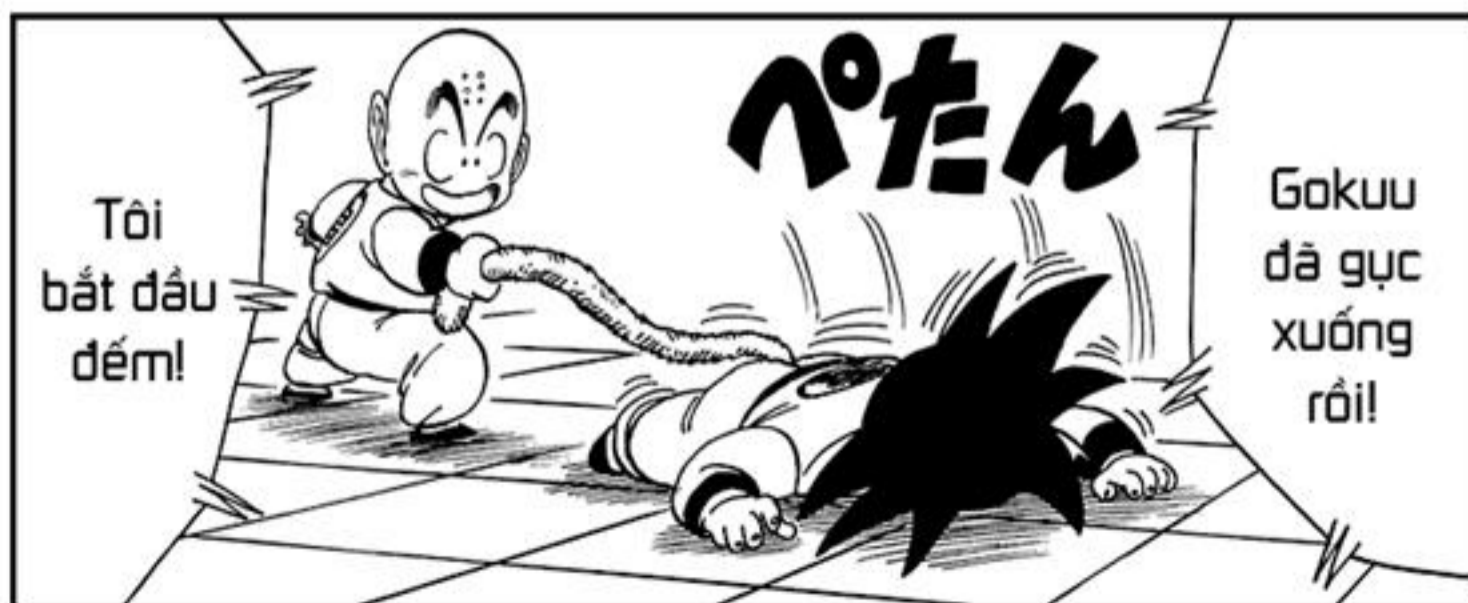
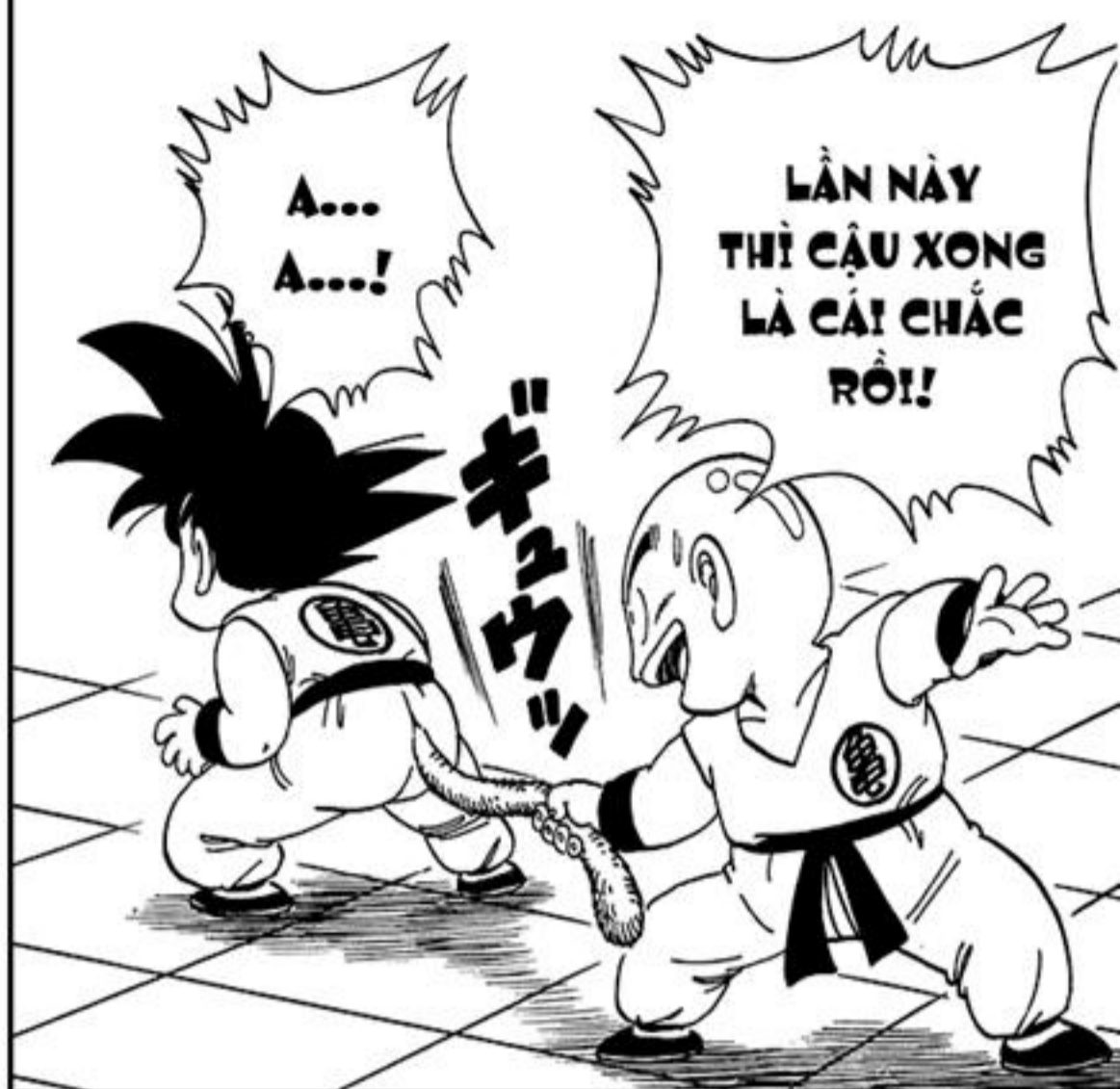





\*T/N: Ý NÓI ĐIỂM YẾU CHỈ MANG CỦA MỘT NGƯỜI - GOOGLE ĐỂ BIẾT THÊM CHI TIẾT

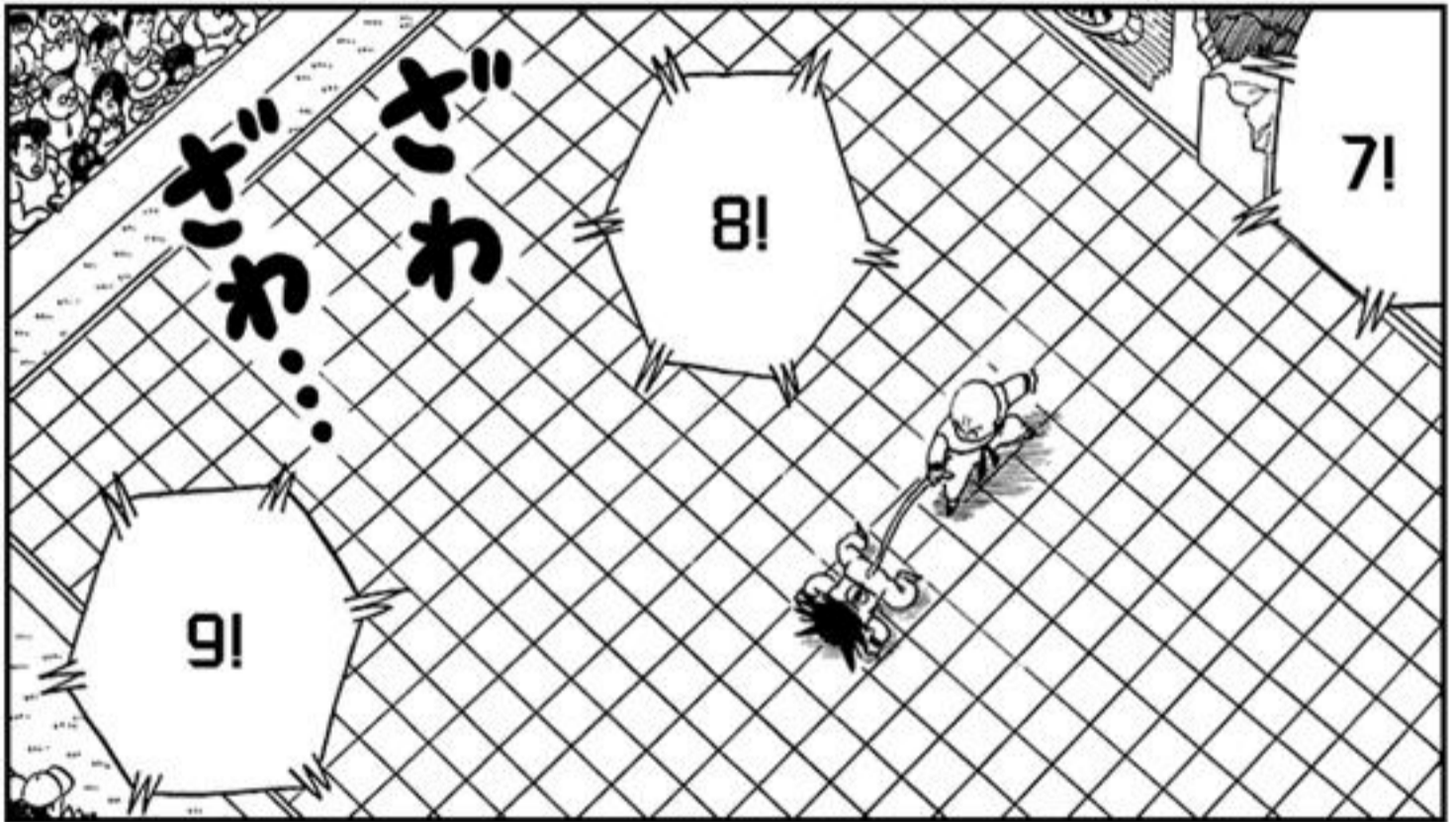



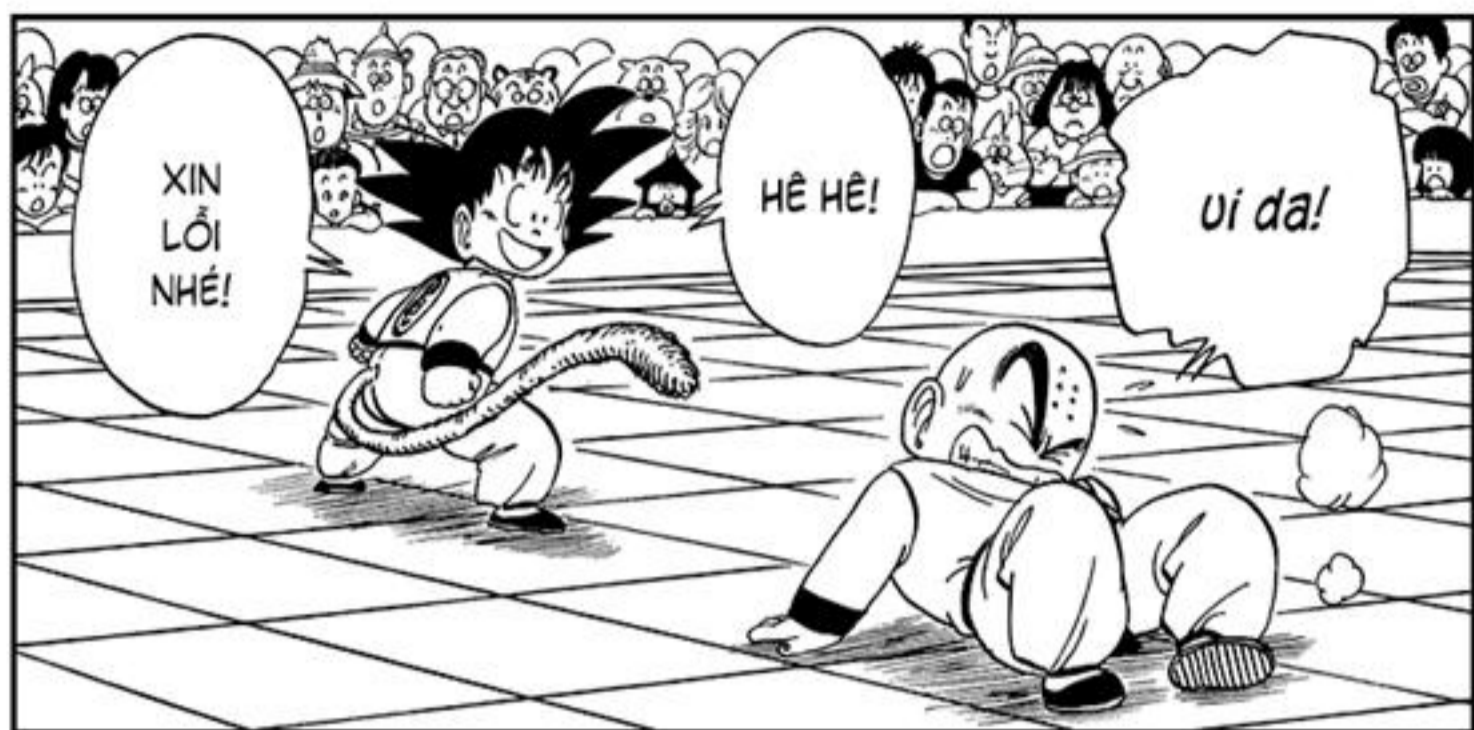

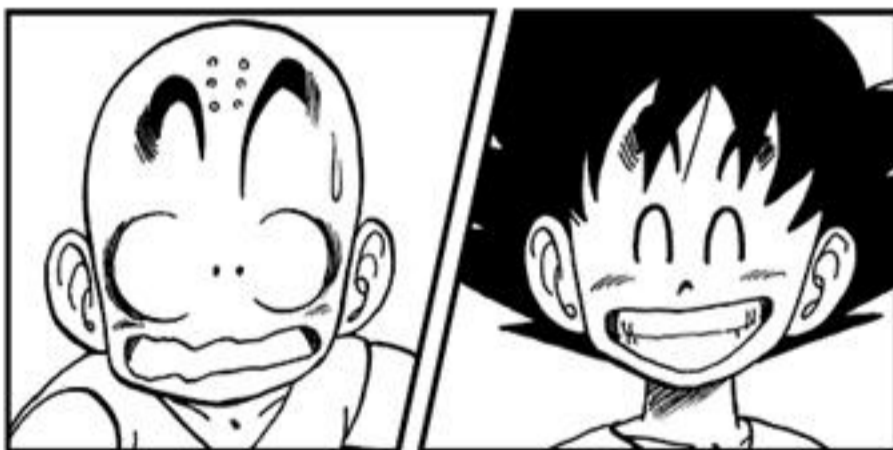

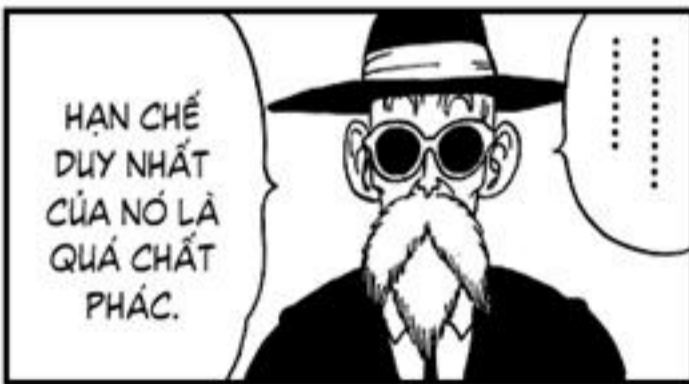
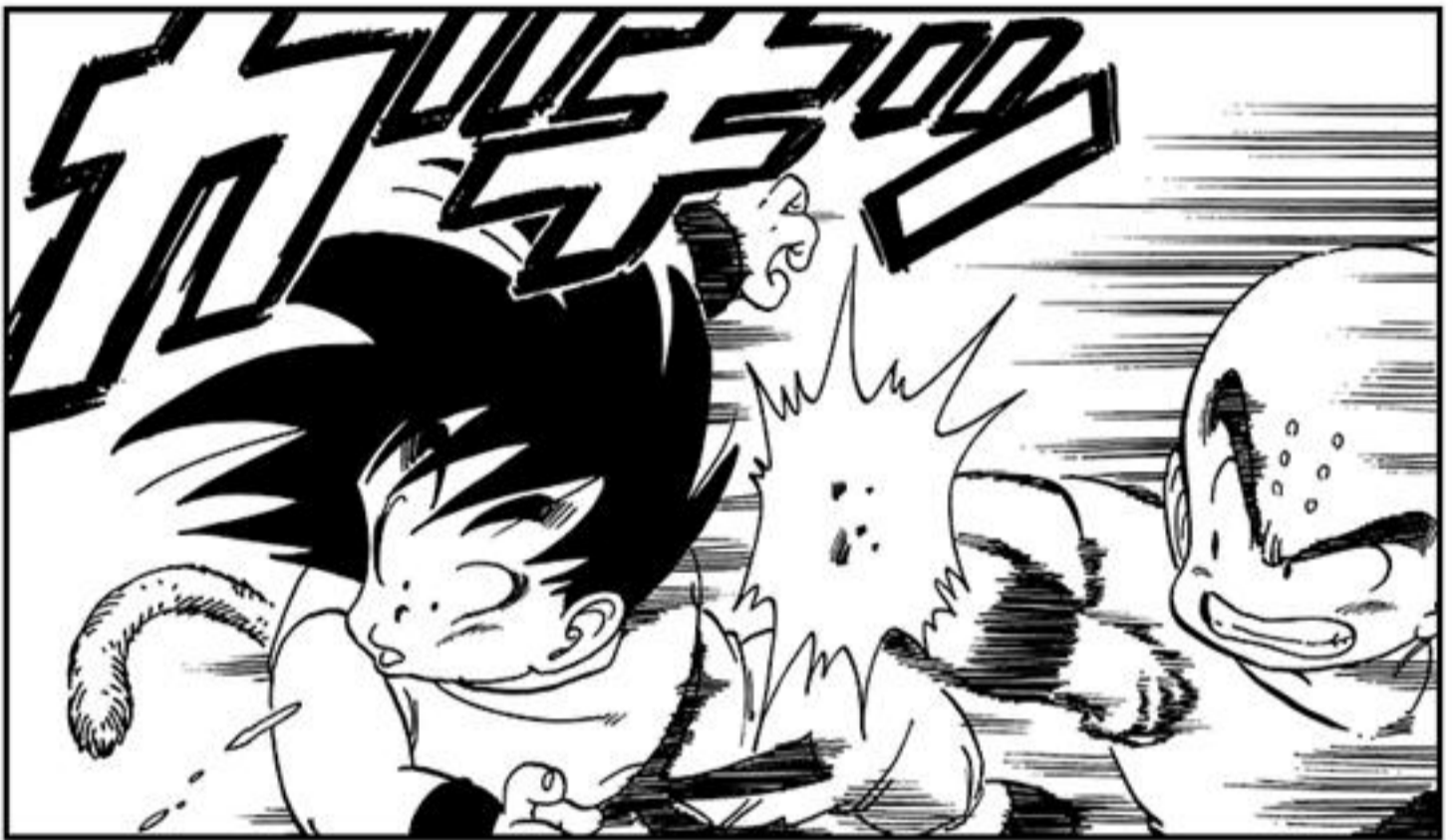
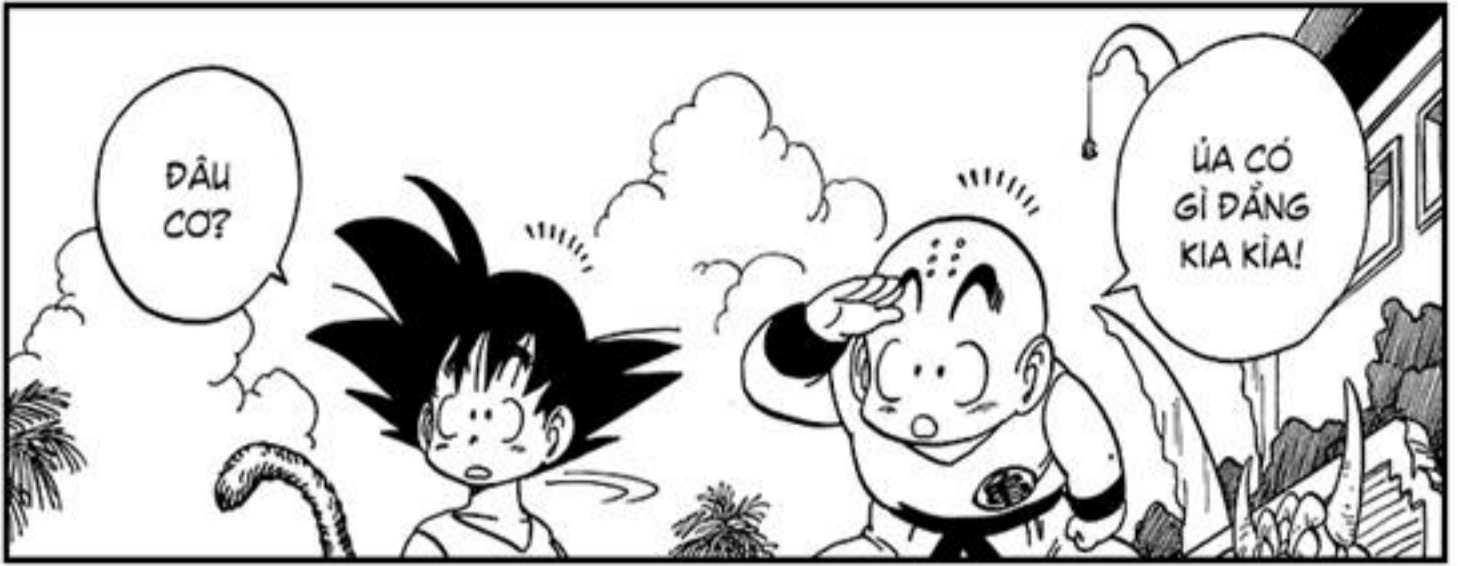

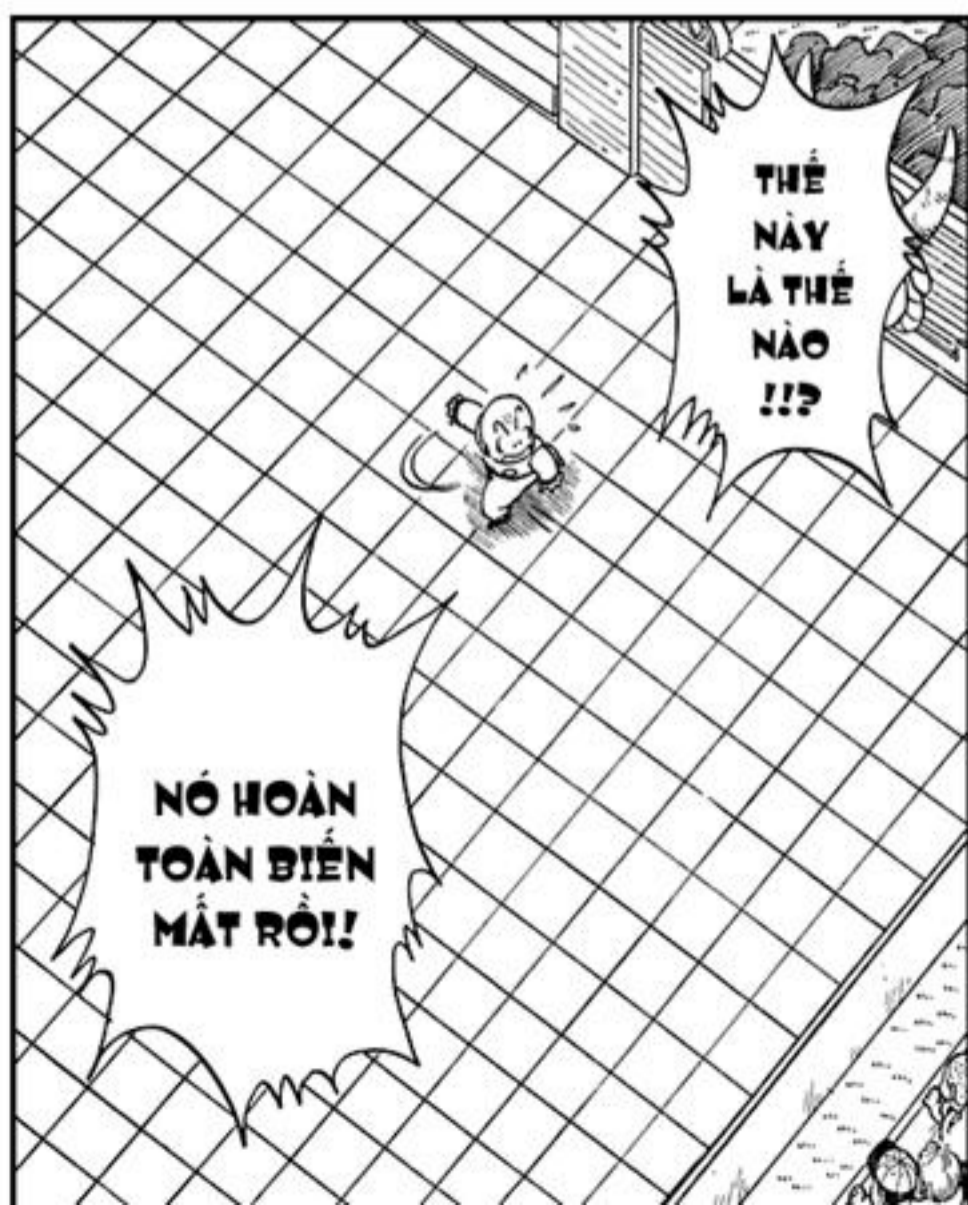



Không thể tin vào mắt mình được nữa! Gokuu đã bốc hơi rồi!

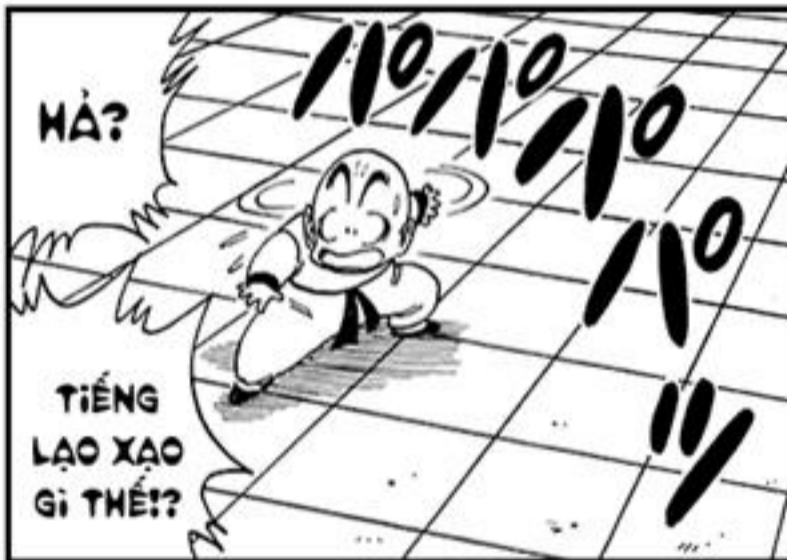

HẢ?

TIẾNG LẠO XẠO GÌ THẾ!?



SAO CÓ THỂ THỂ ĐƯỢC!



NÓ CHẮC CHẴN VẪN Ở TRÊN VÔ ĐÀI!



TUY KHÔNG NHÌN THẤY NÓ NHƯNG ...

MÌNH CÓ THỂ CẢM THẤY NÓ...

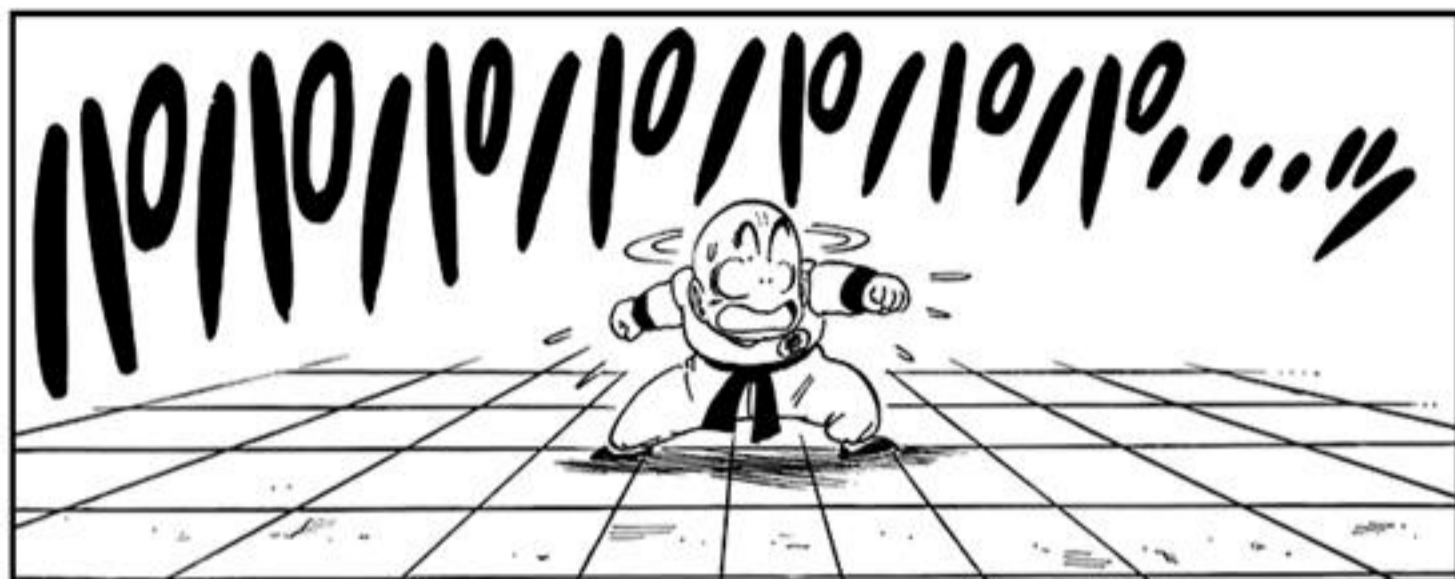

CÒN TIẾNG  
LẠO XAO ĐÓ...  
CHẮC CHẮN LÀ  
TIẾNG BƯỚC CHÂN  
CỦA NÓ!



NHỜ CON  
MẮT THỨ 3 NÀY  
MÀ MÌNH CÓ  
THỂ LỜ MỜ  
THẤY NÓ...

NÓ ĐANG ĐI  
CHUYỂN VỚI  
MỘT TỐC ĐỘ  
CỰC KÌ KHỦNG  
KHIẾP!





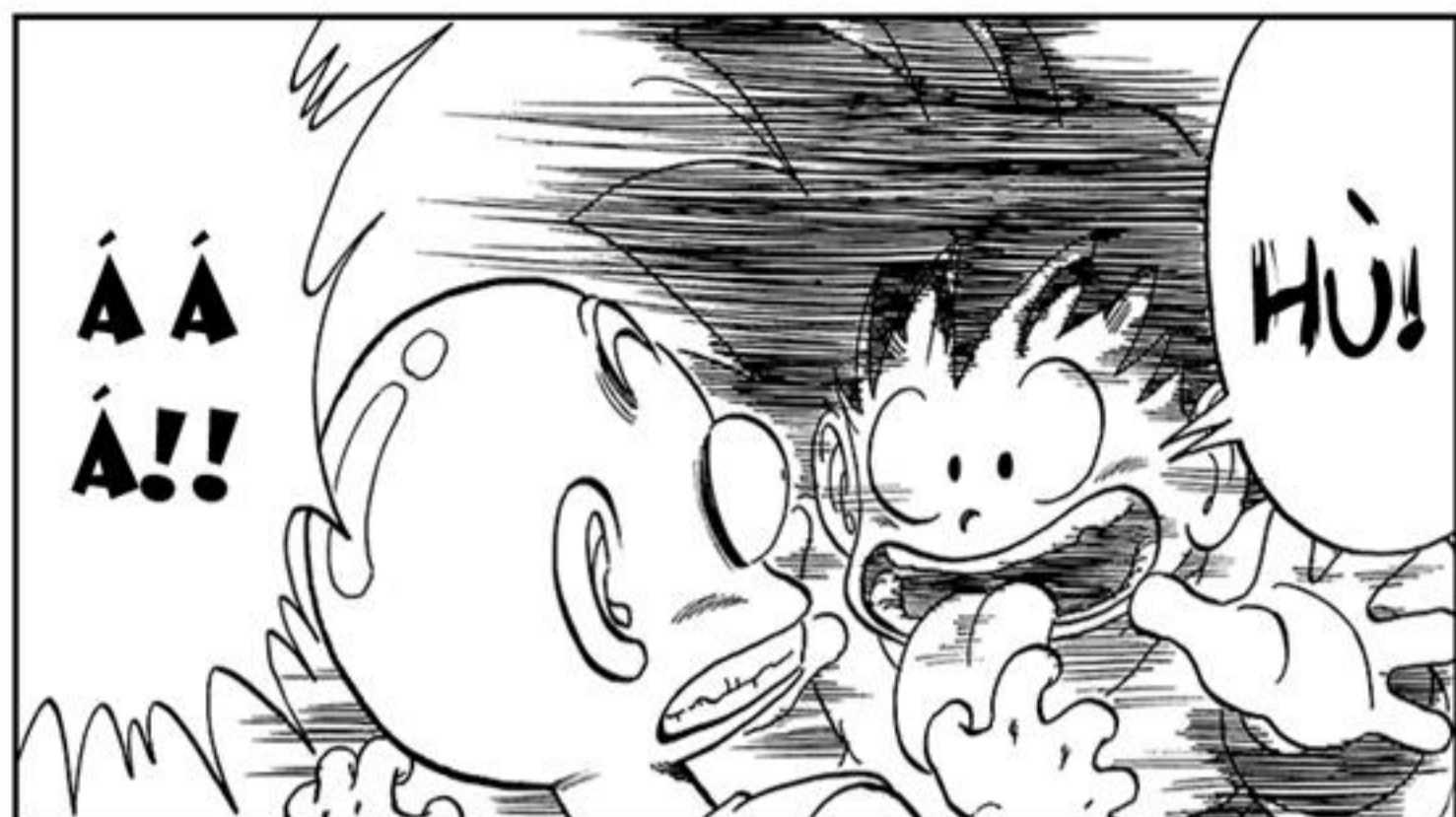

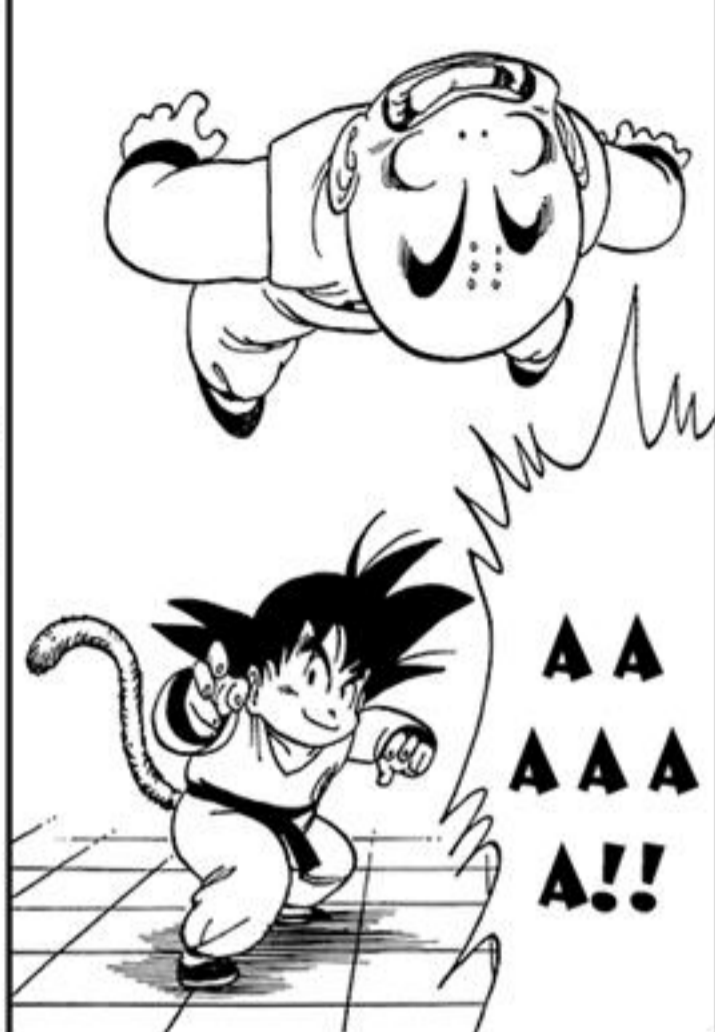

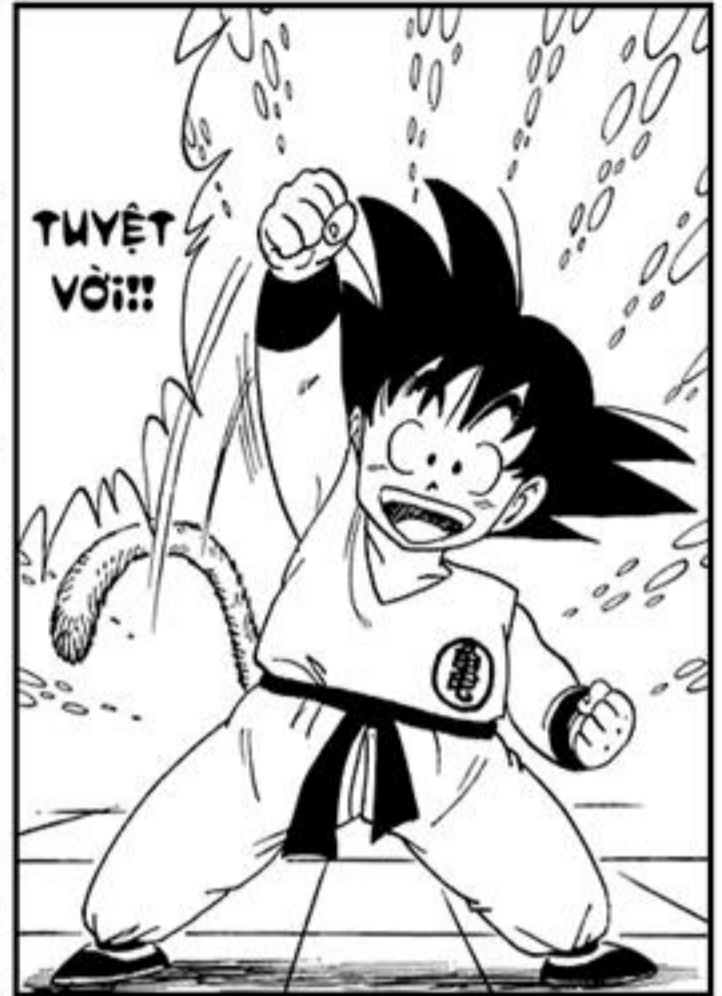
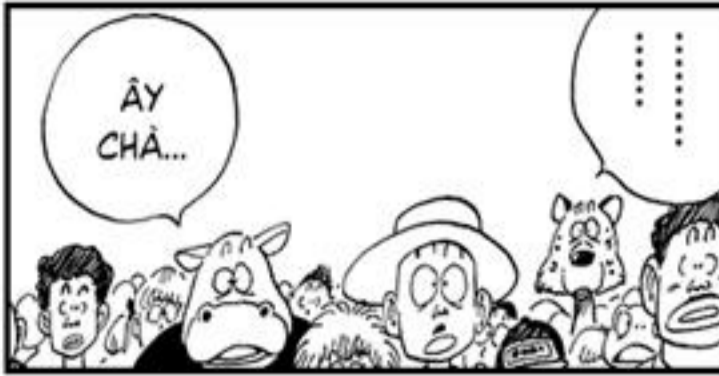



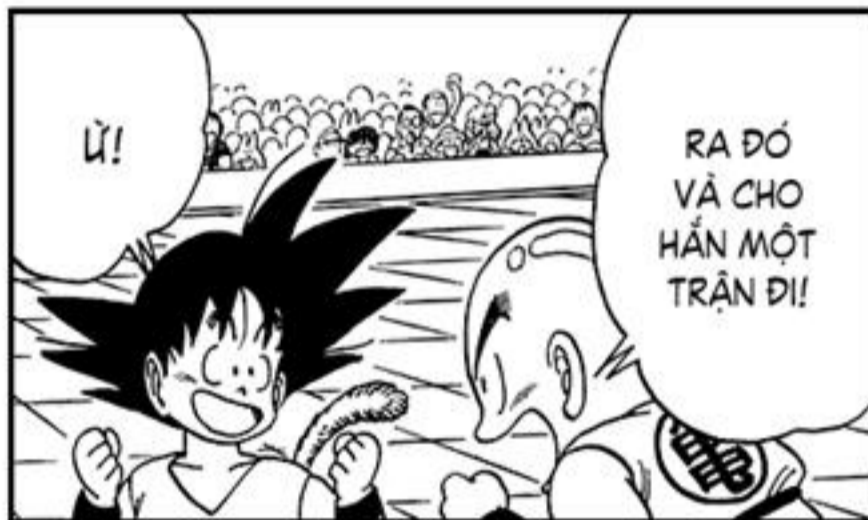

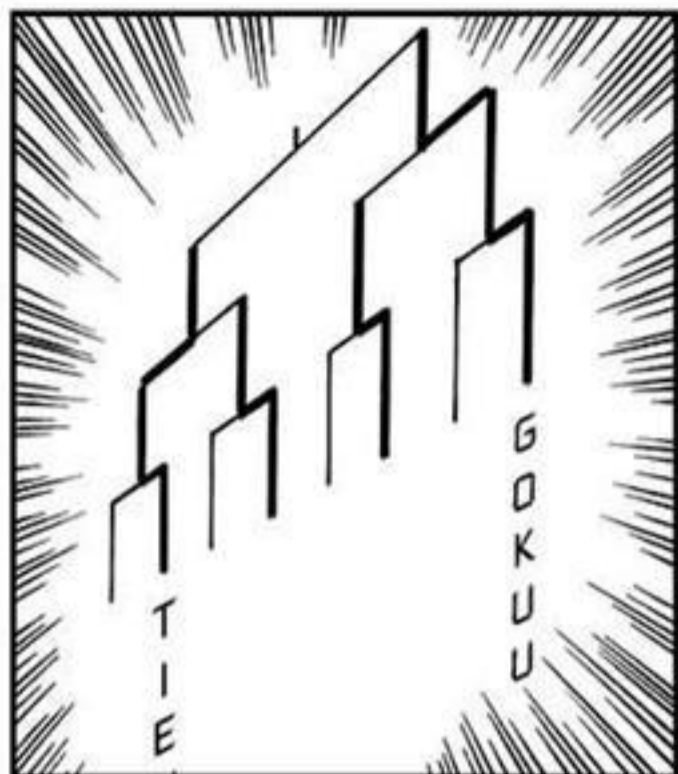

kì đại hội võ thuật lần thứ 22 này quy tụ tổng cộng 182 võ sĩ, xin cảm ơn các bạn đã đăng kí tham gia giải năm này!

và giờ, đối mặt với nhau trong trận chung kết là hai võ sĩ xuất sắc nhất: Tien và Gokuu!

tất cả mọi người đều đang chờ đợi khoảnh khắc này! khoảnh khắc của sự trình diễn huy hoàng và tuyệt đỉnh!





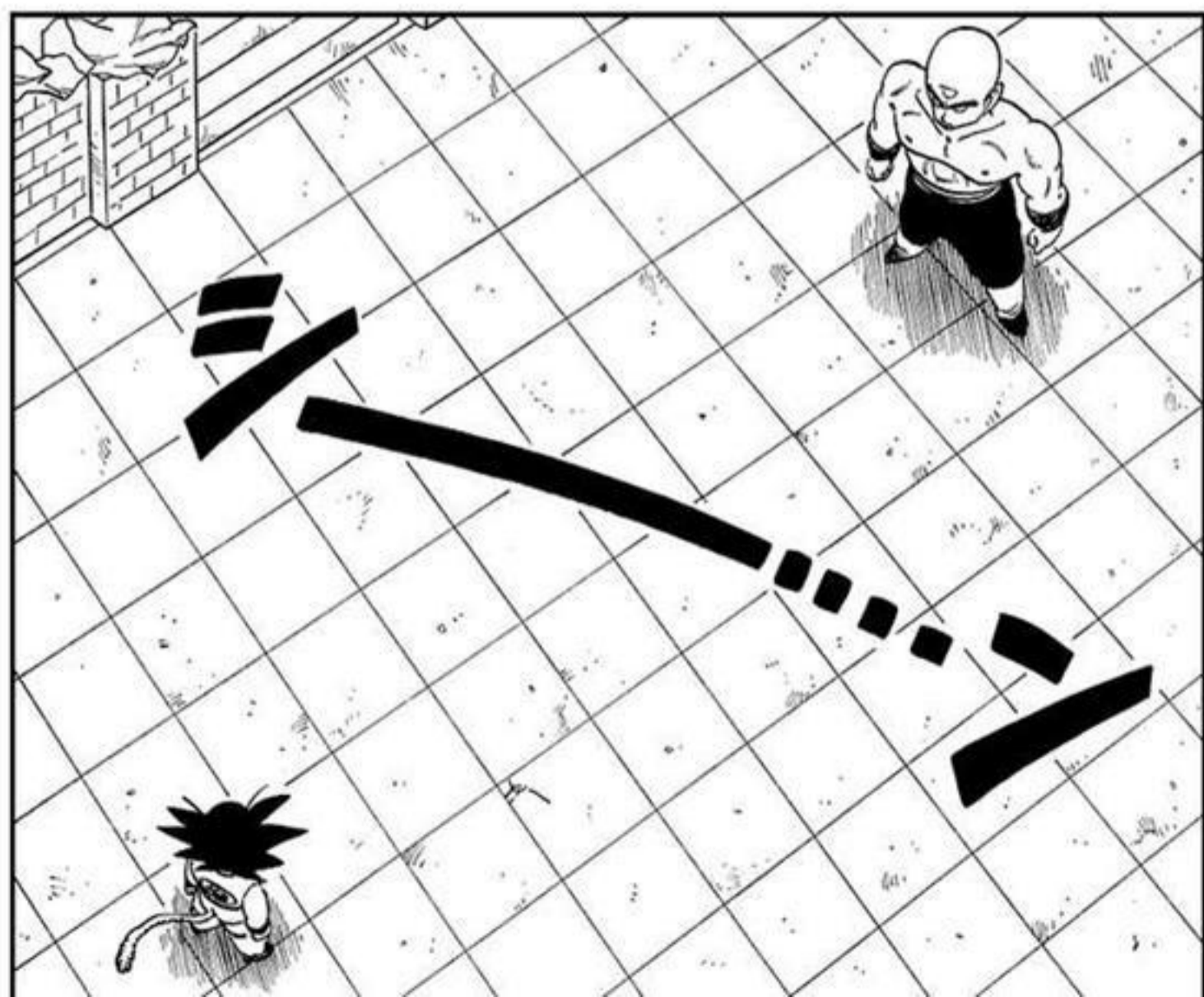



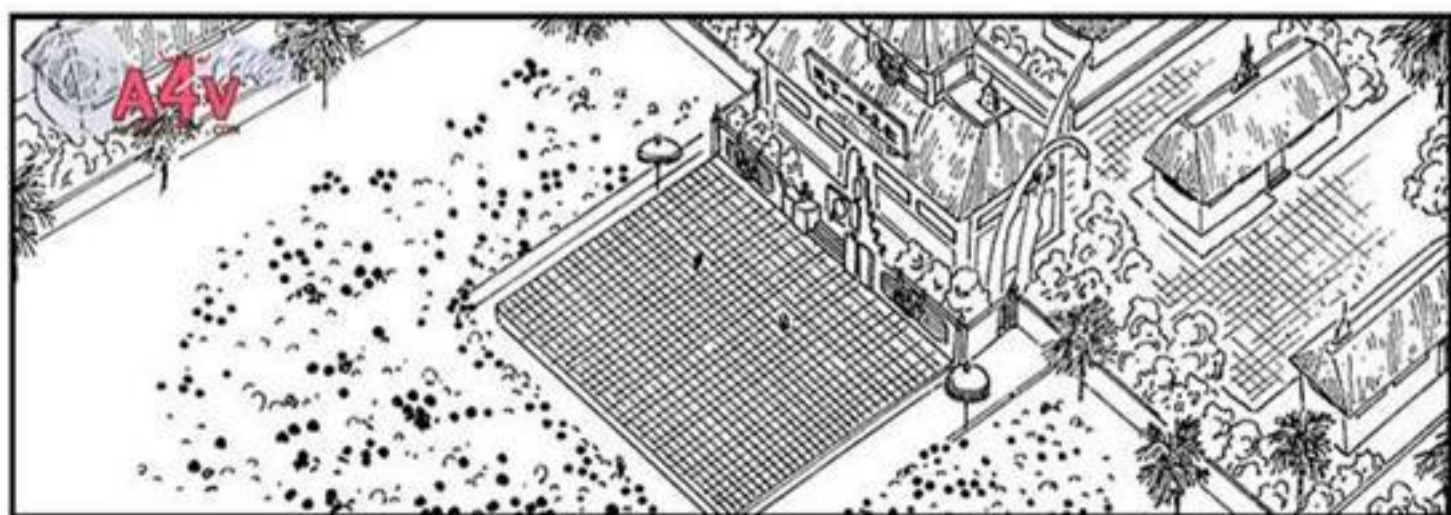









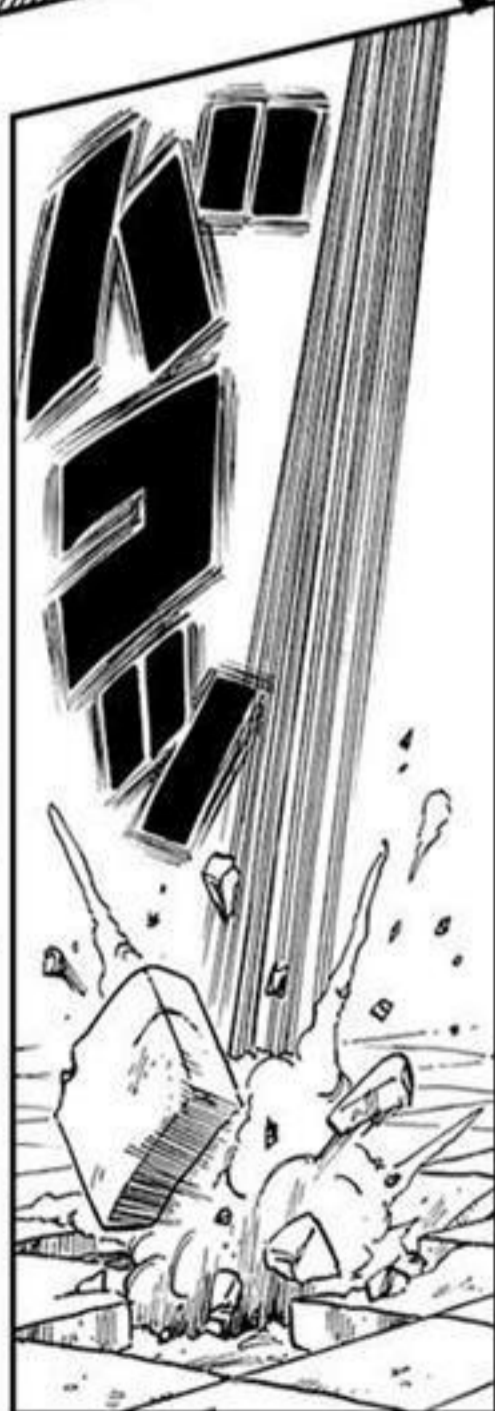





Goku  
lại biến  
mất nữa  
rồi!

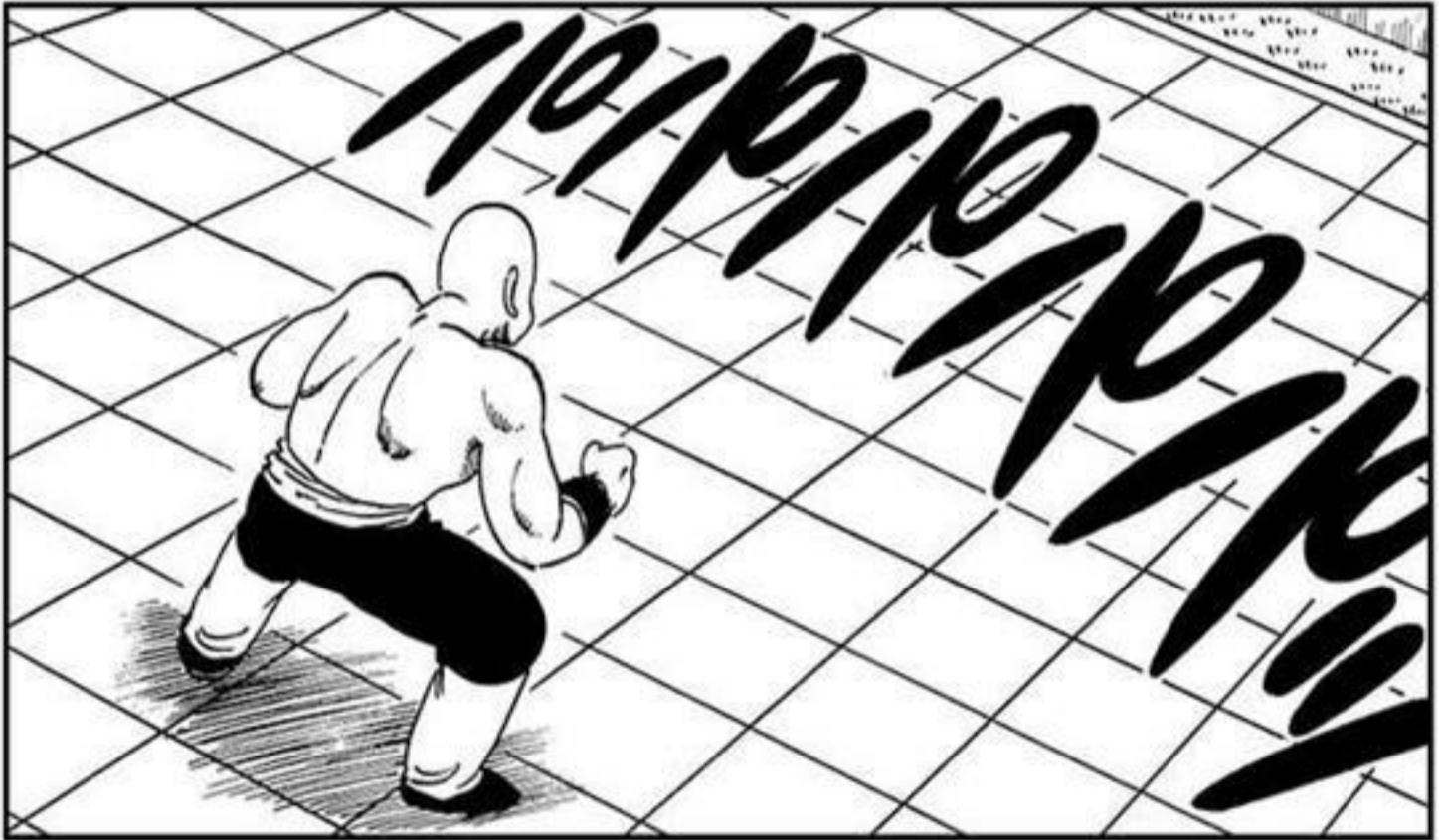





**NGƯỜI  
Ở ĐÂY  
CHỨ  
GÌ!**



**TRÒ  
VẬT VẠN  
ĐỒ CHẴNG  
TÁC DỤNG  
VỚI TA  
ĐÀU!**

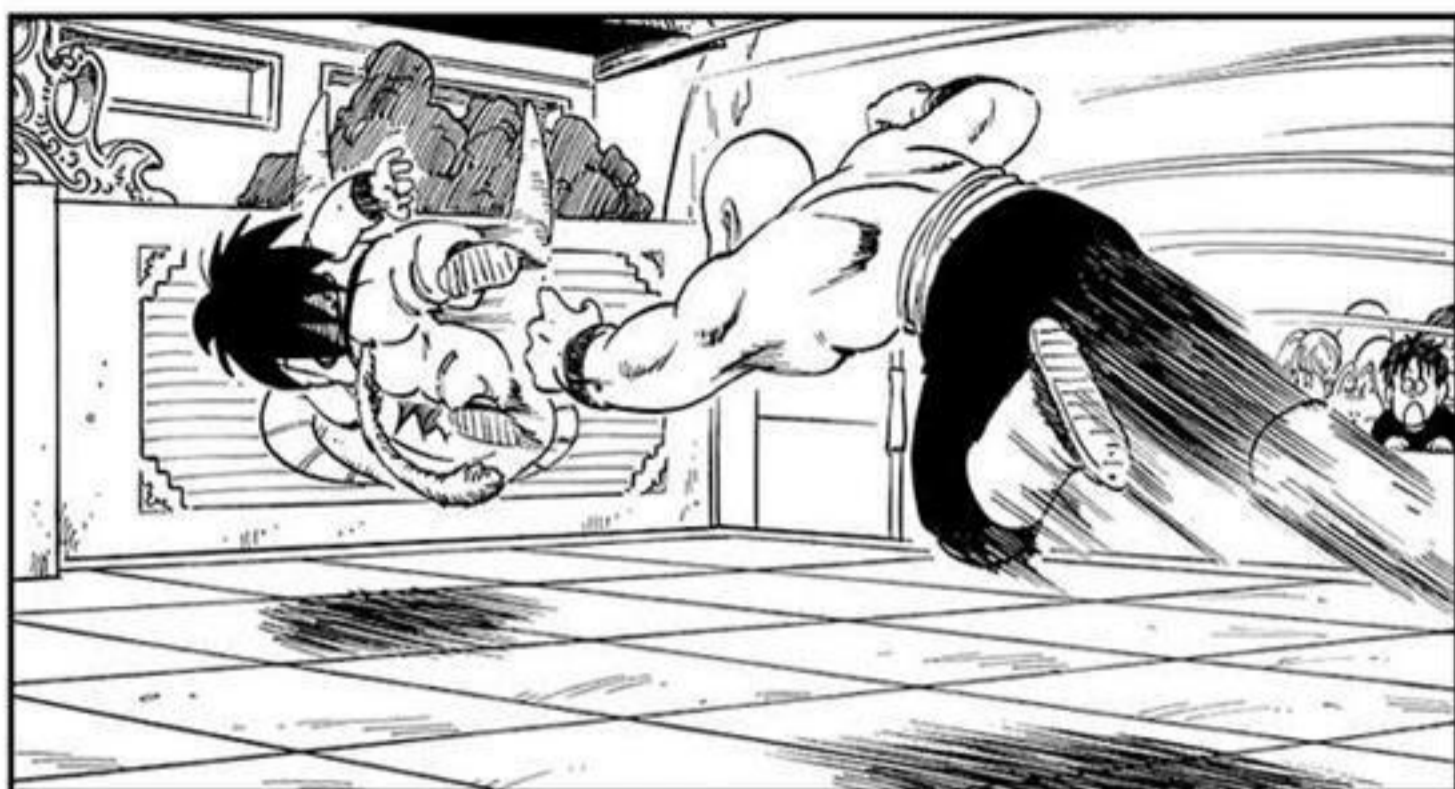

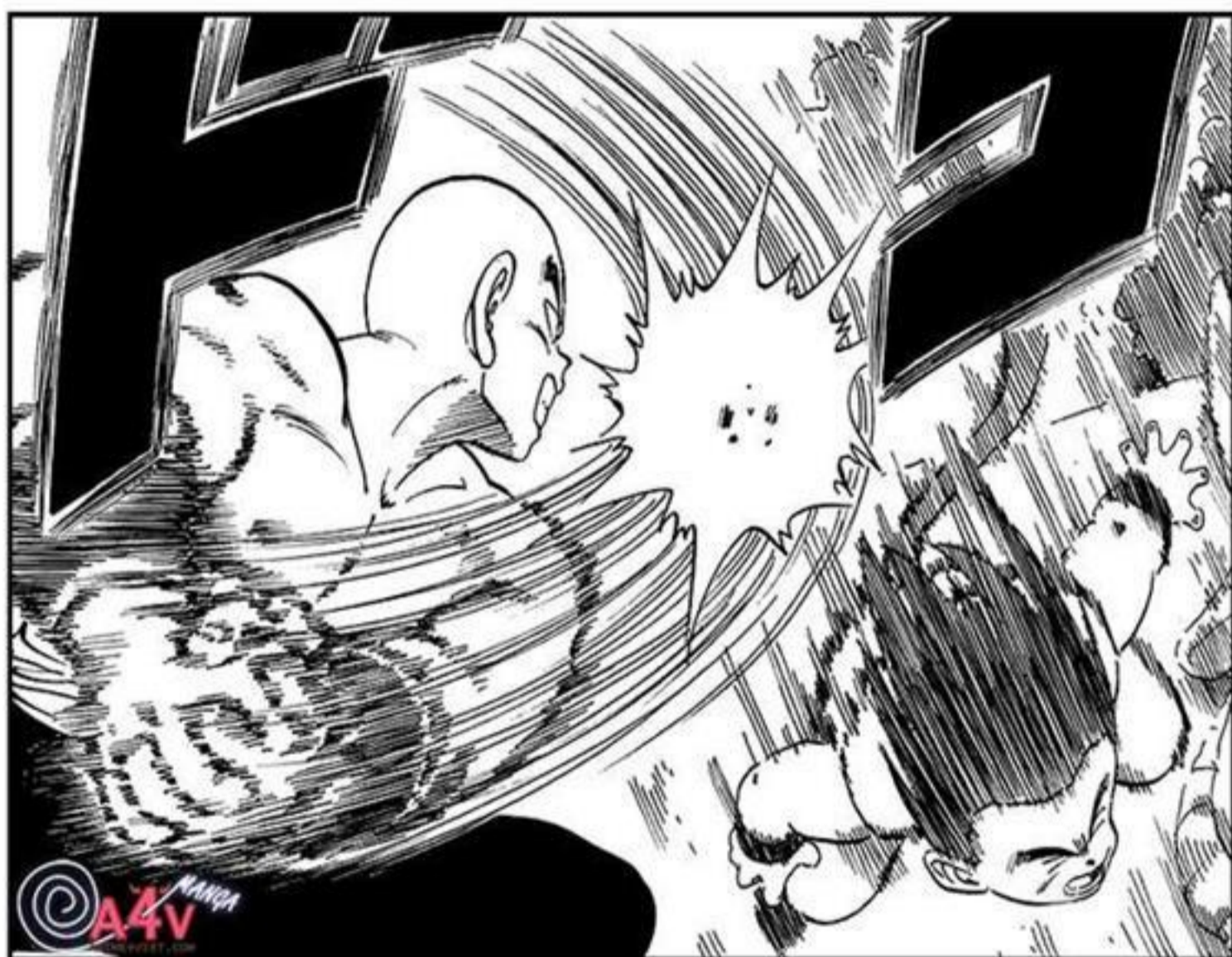

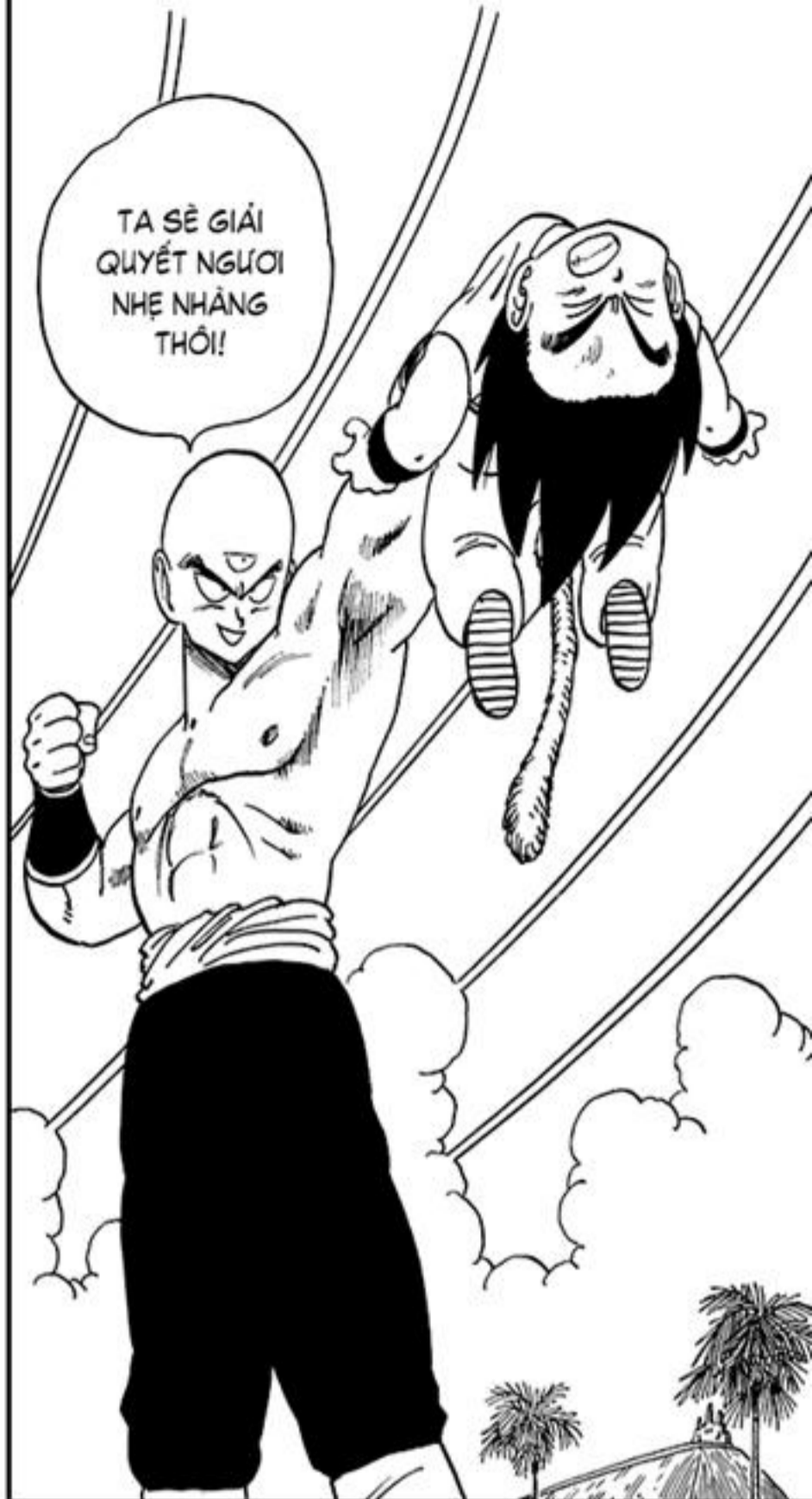



**HAI-  
KYU  
KEN!**

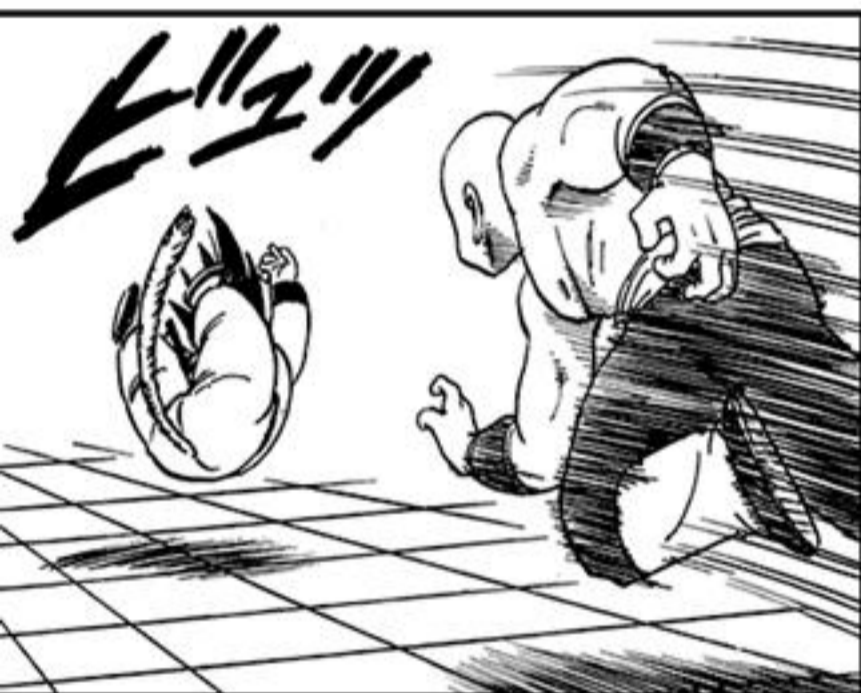

**ゴッ**



**YAA  
AI!**



**ゴッ**











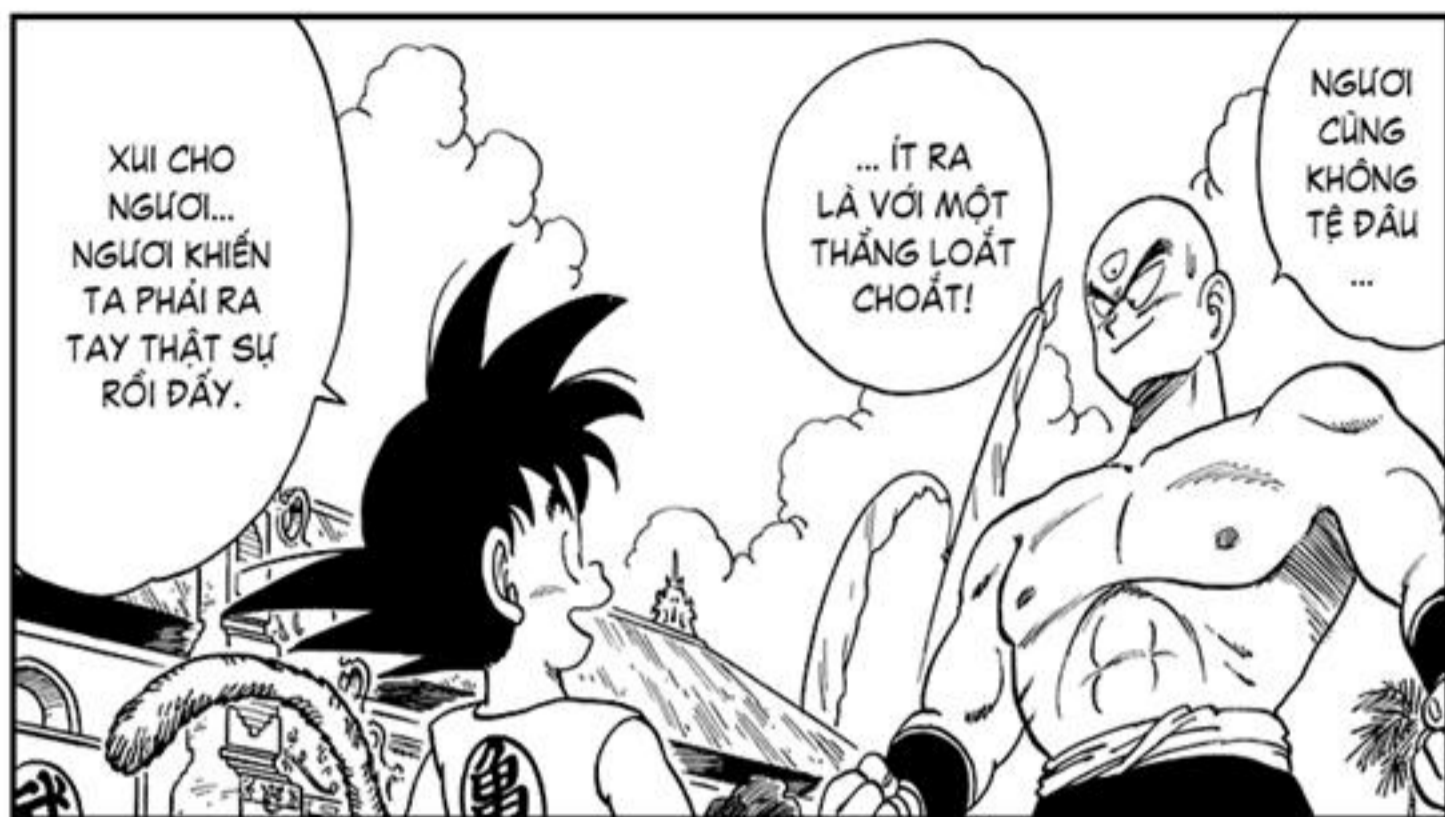

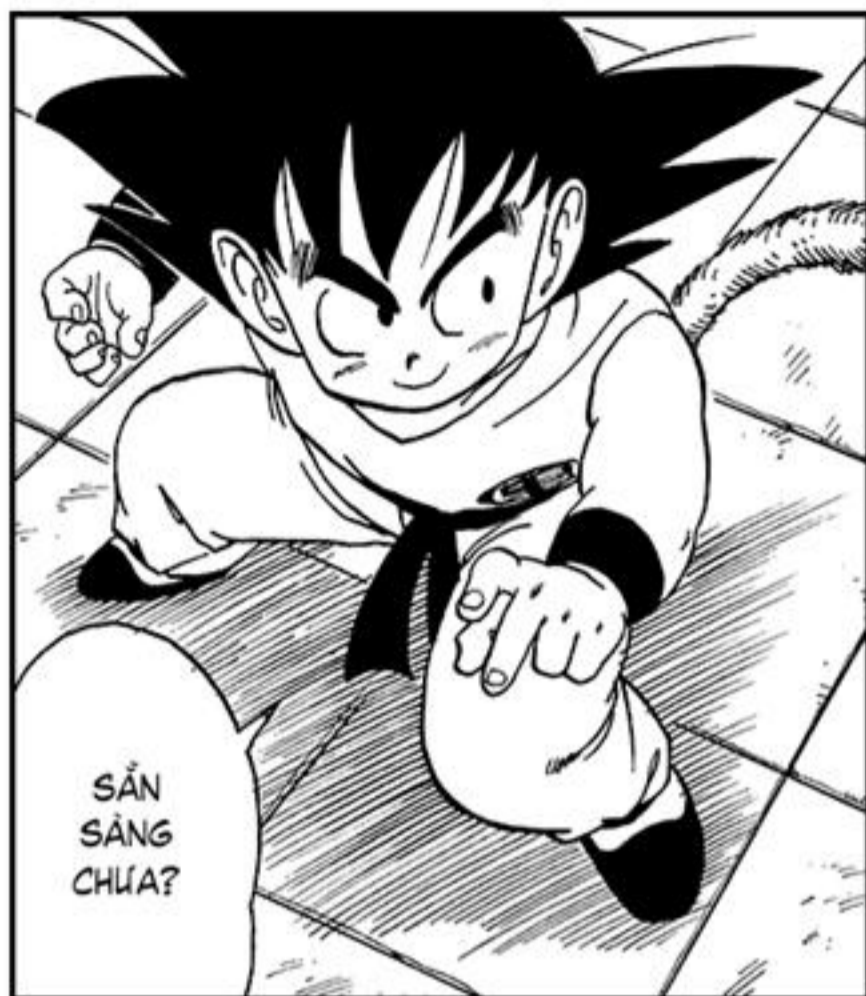

SẴN  
SẴNG  
CHƯA?



KHÔNG  
CẦN PHẢI  
LỚN LỎI!

BIỂU HIỆN  
LÚC NÀY  
CỦA NGƯỜI  
ĐÃ LÀ  
QUÁ GIỚI  
HẠN RỒI!



TÔI THỬ  
TA COI!

RỒI  
ĐẤY.

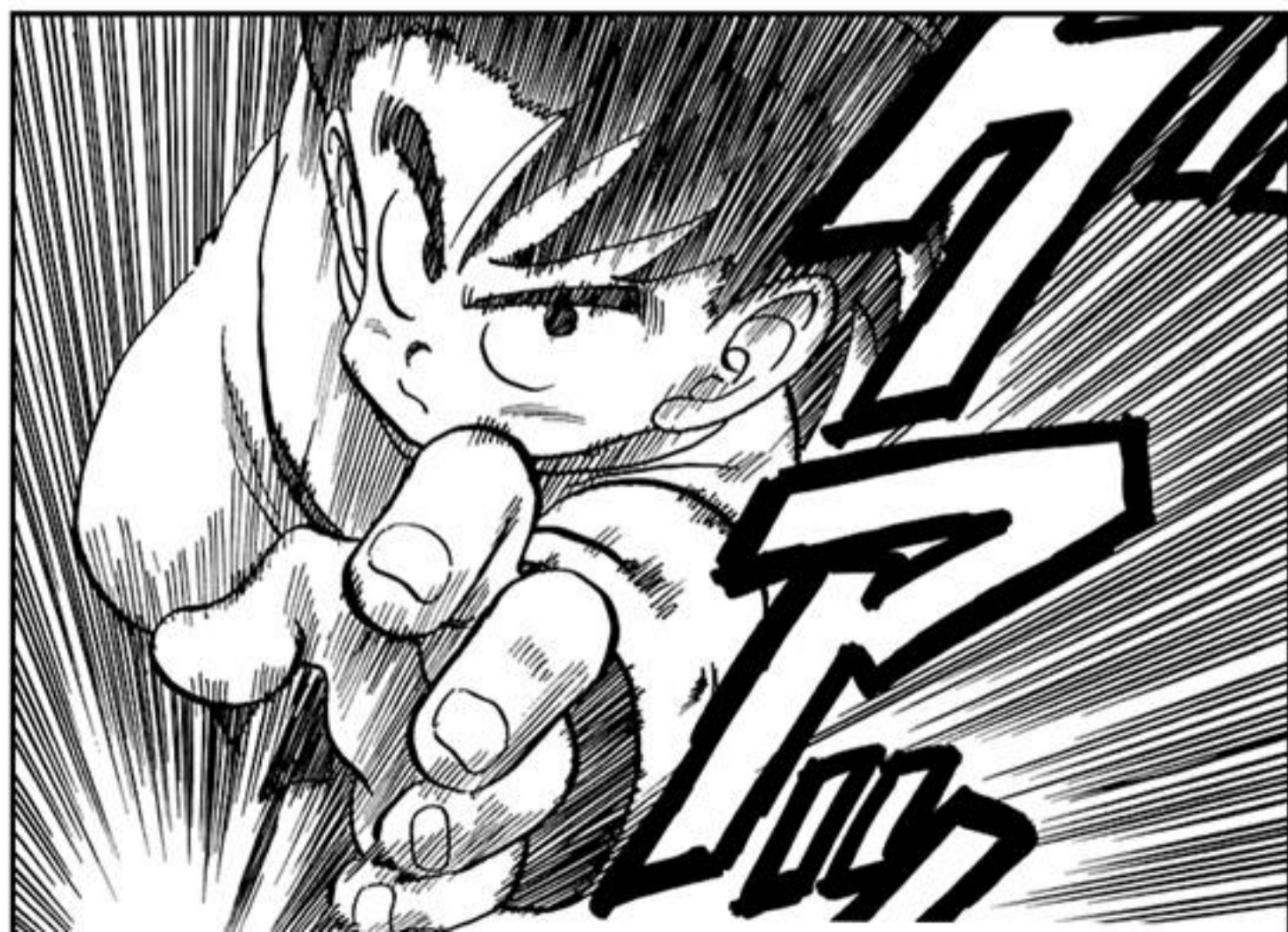

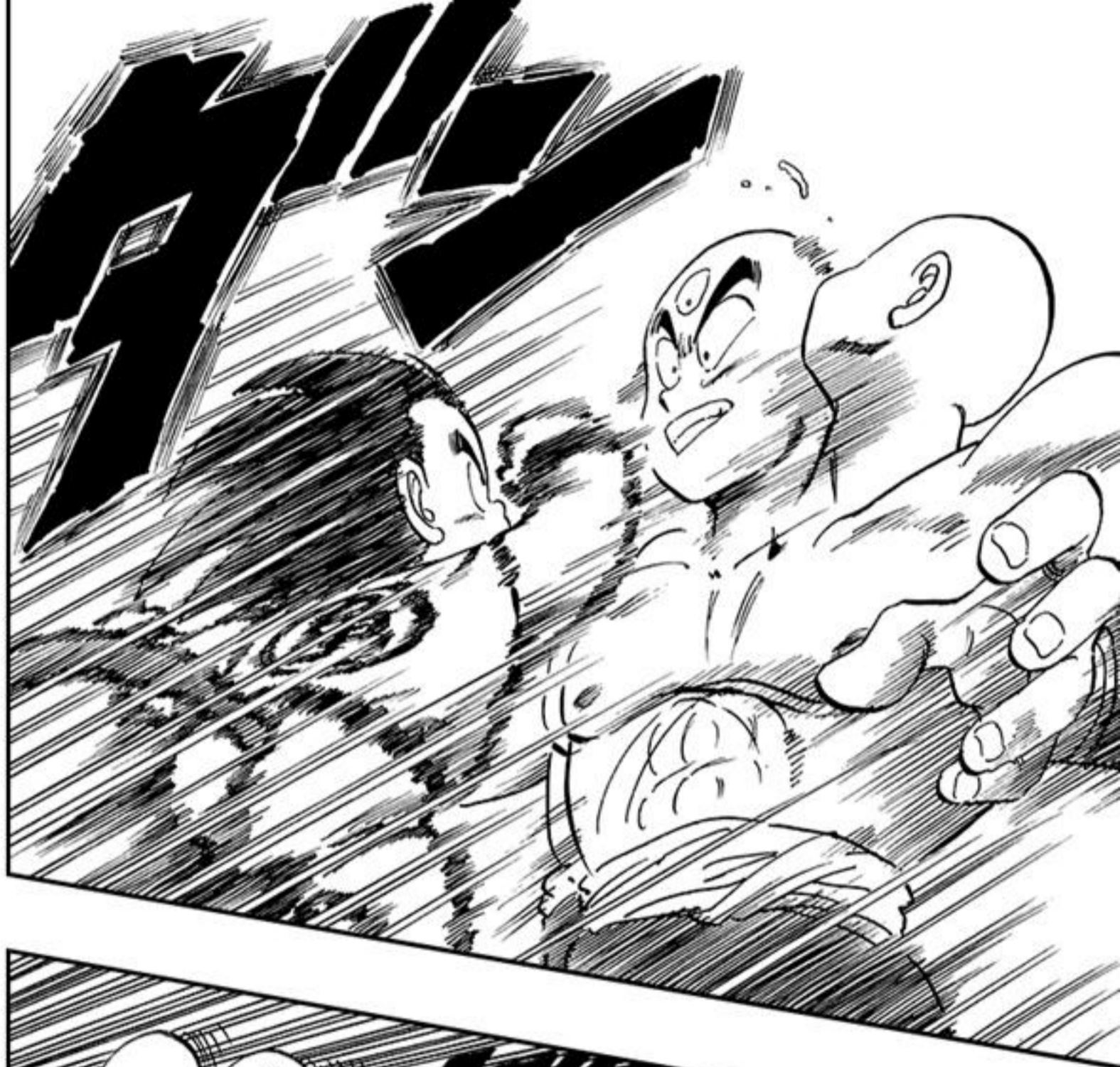

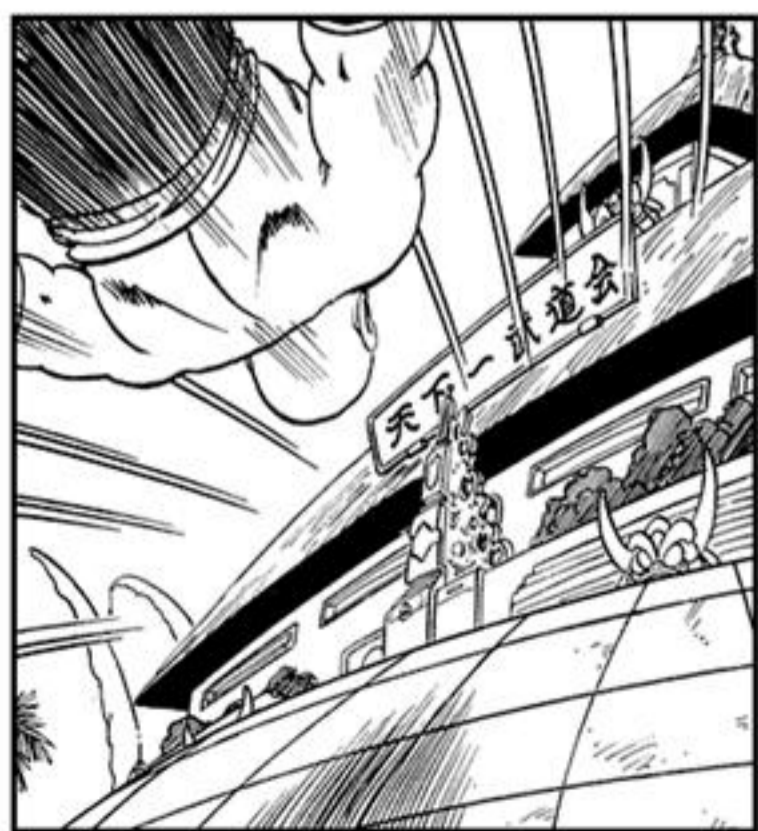









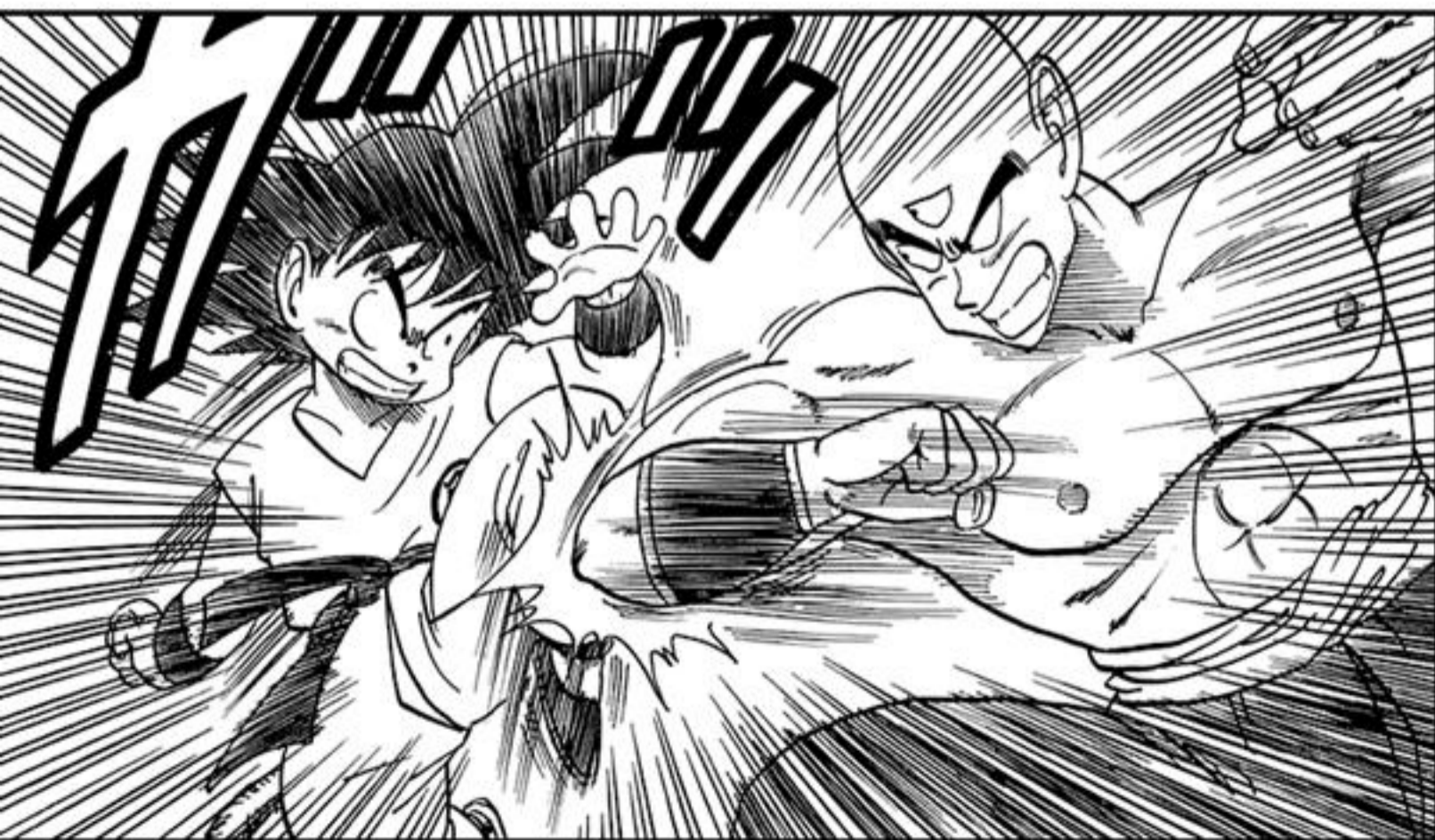







TRƯỢT RỒI!

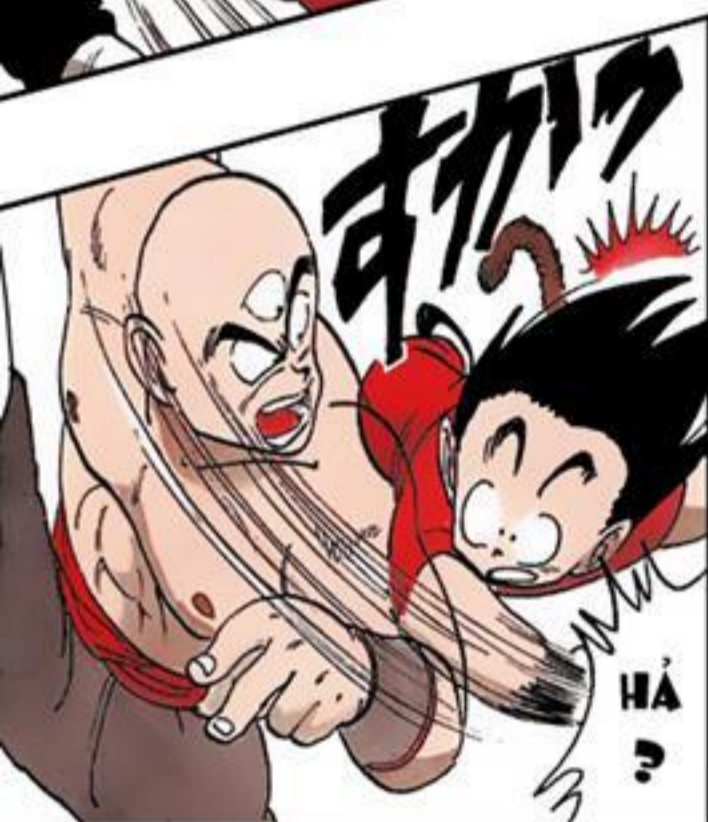

HẢ ?



YA  
AA!



CŨNG  
TÔI  
LÚC  
KẾT  
THÚC  
RỒI!

PHẢI  
THỂ  
CHỮ!

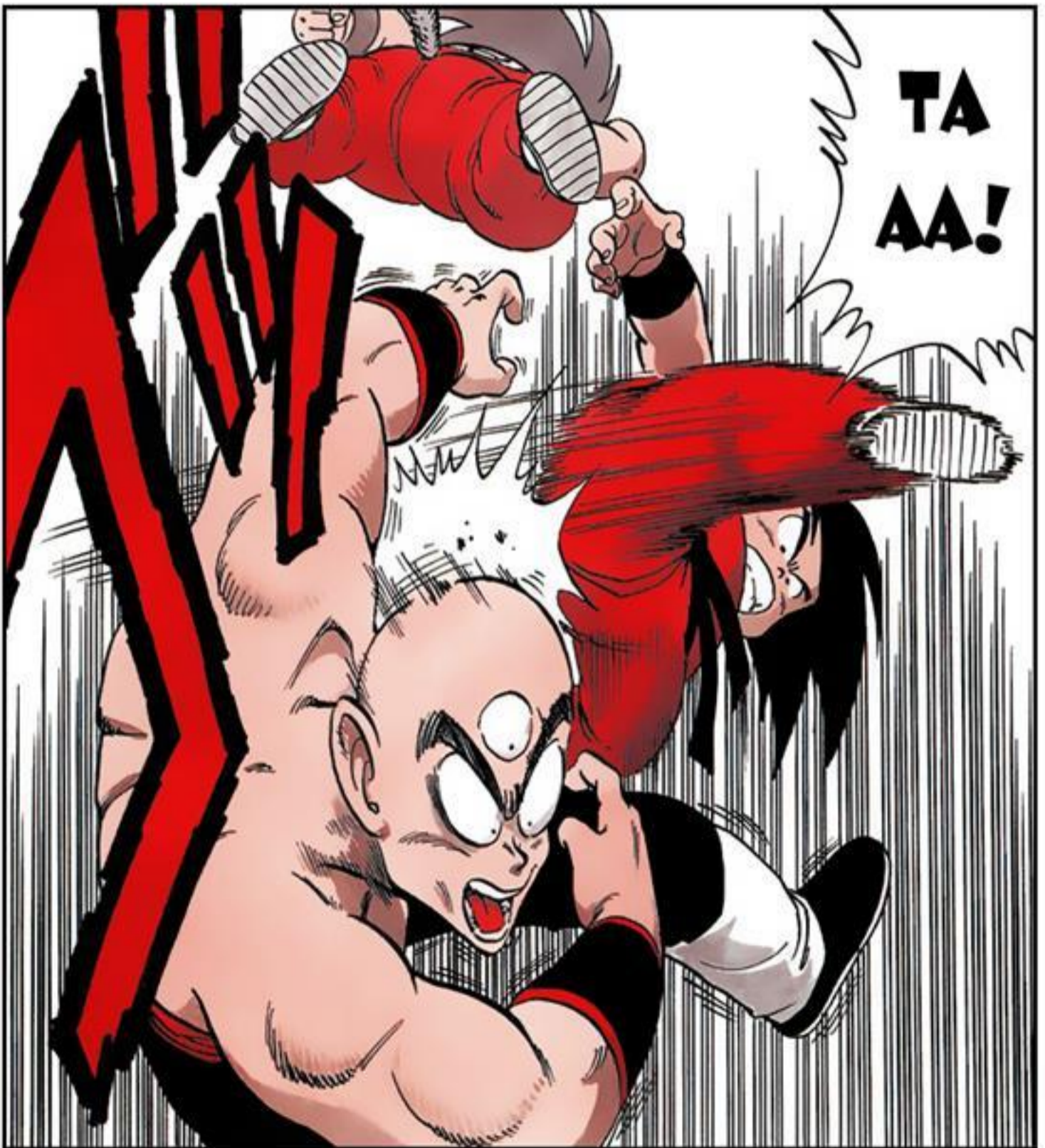
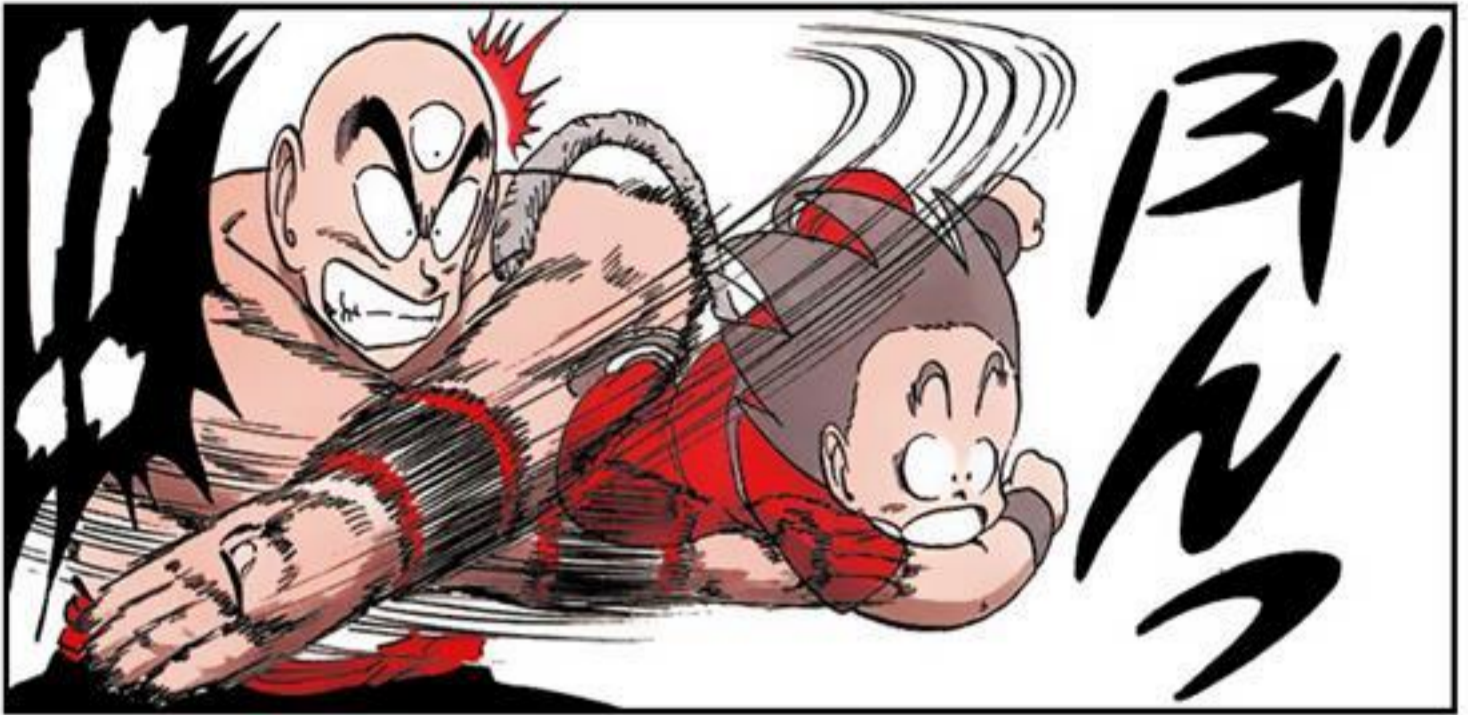



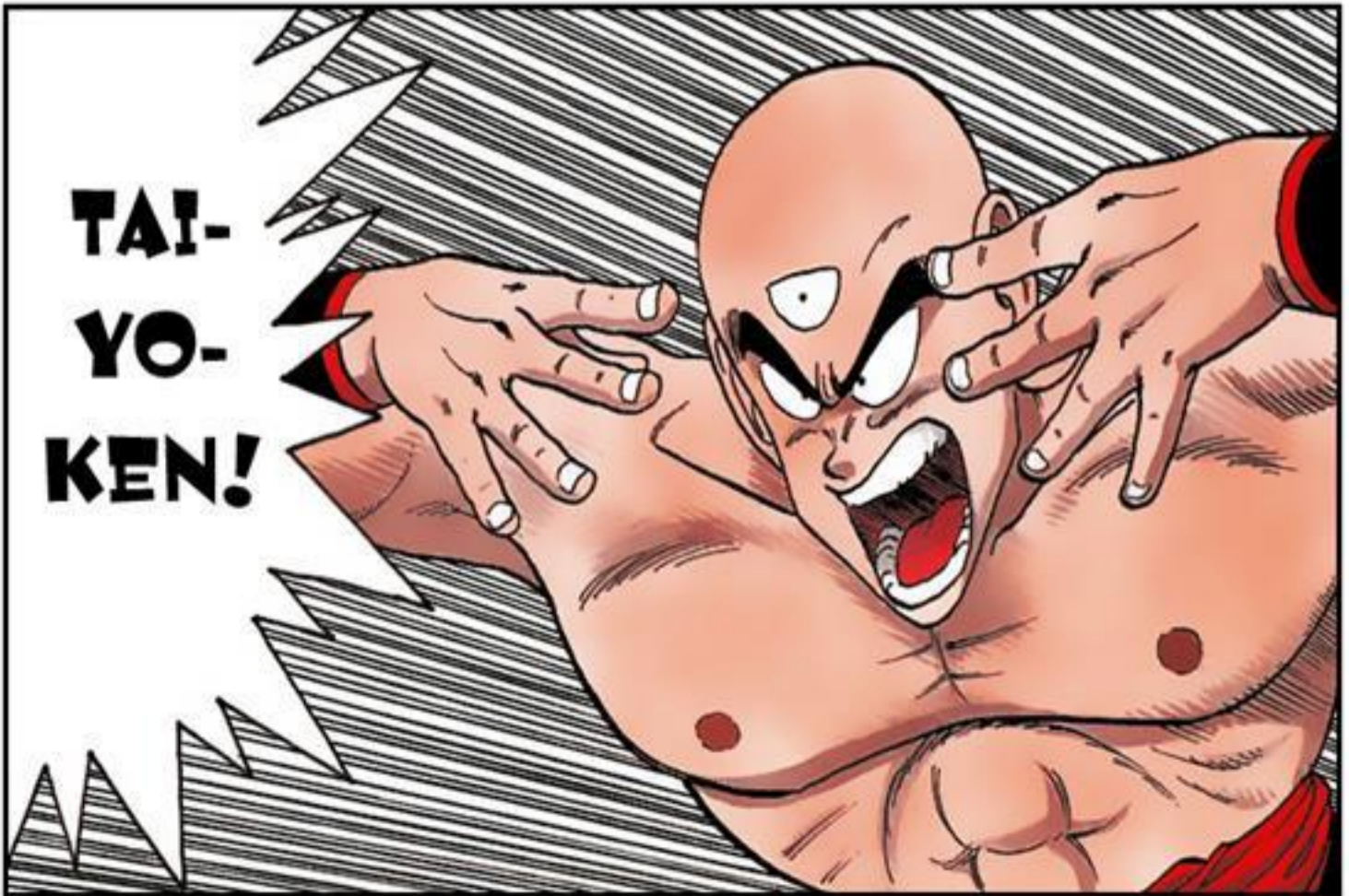
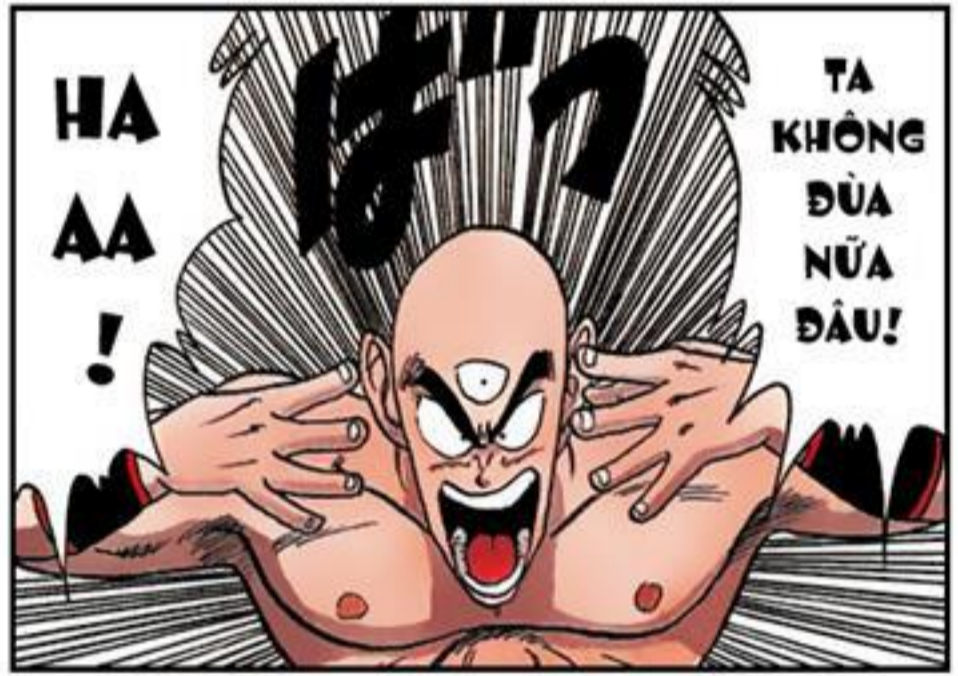





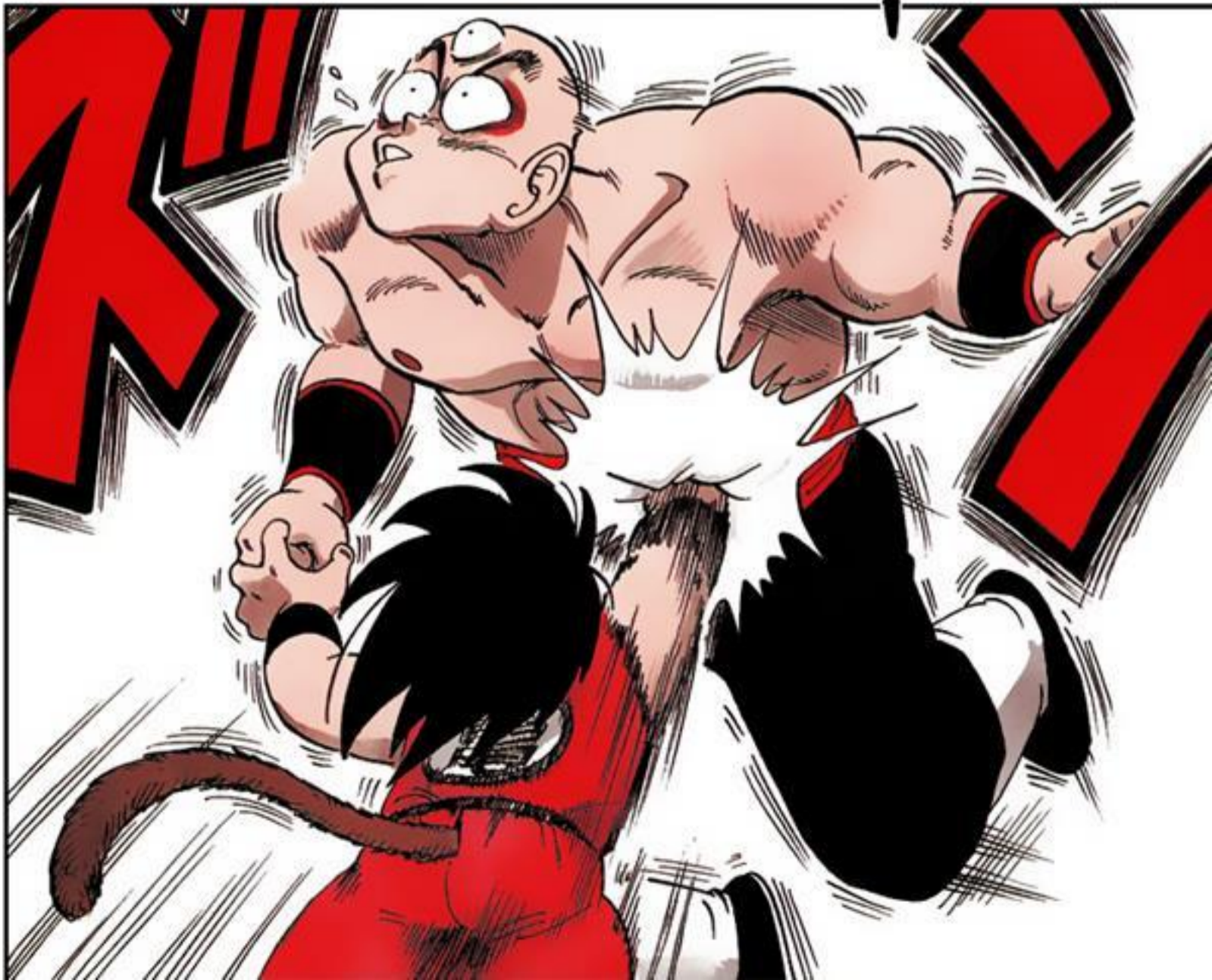
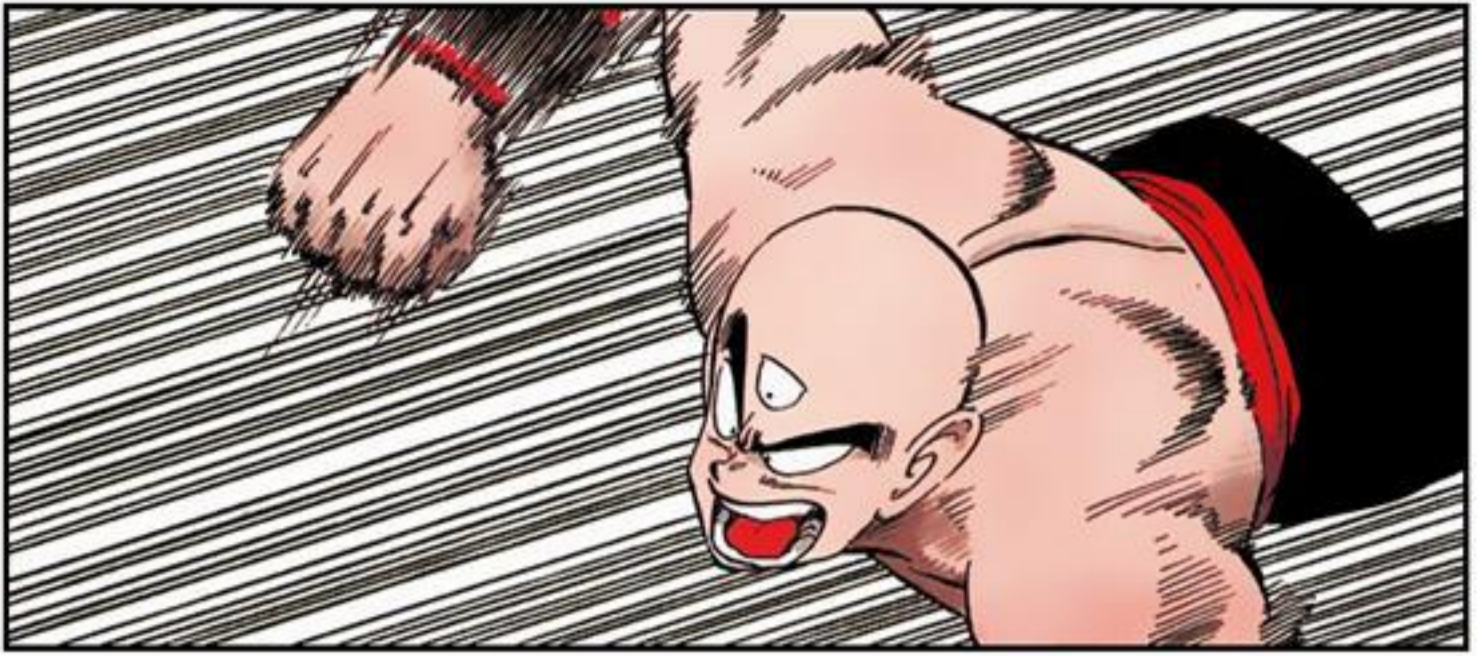



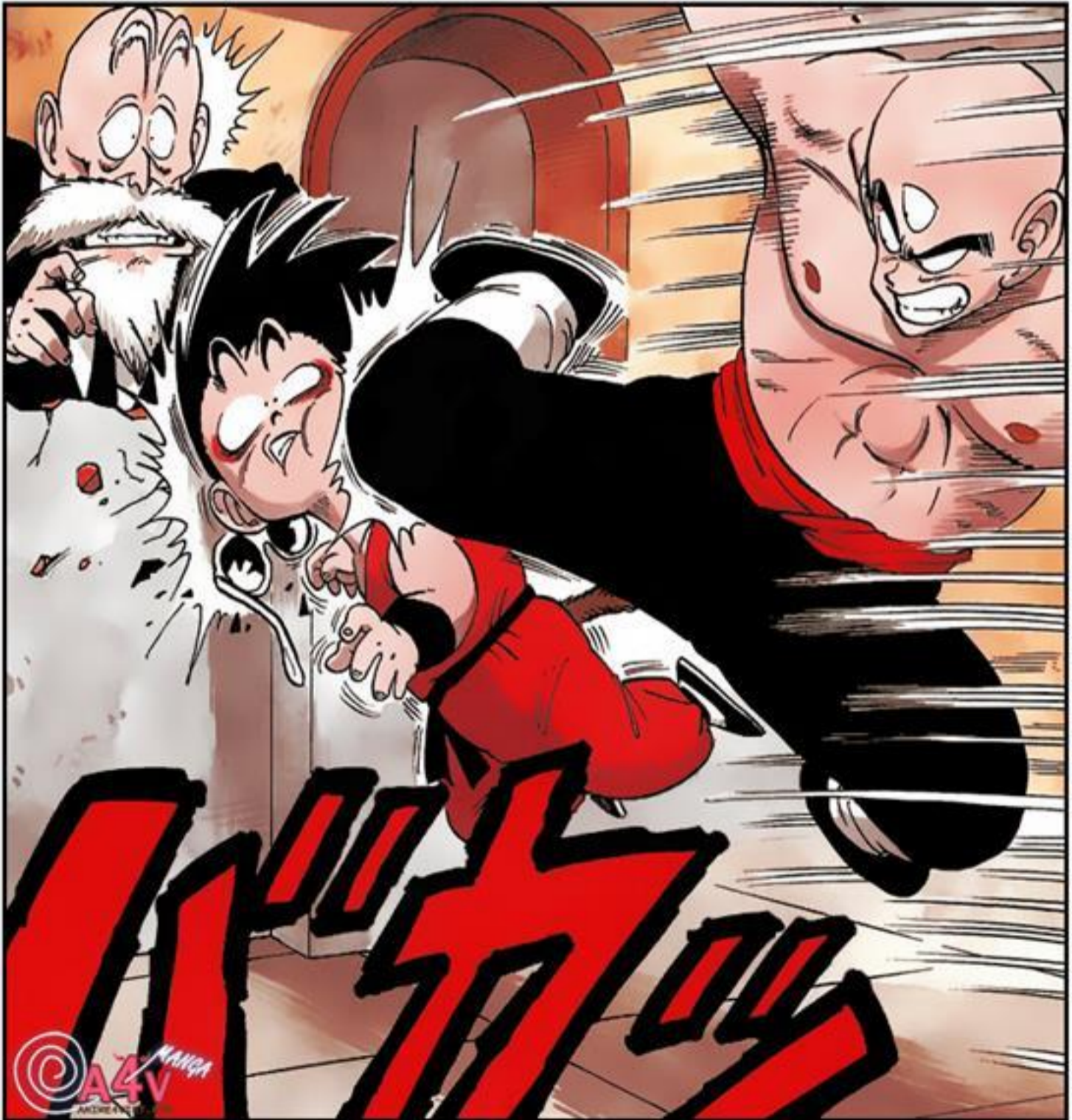

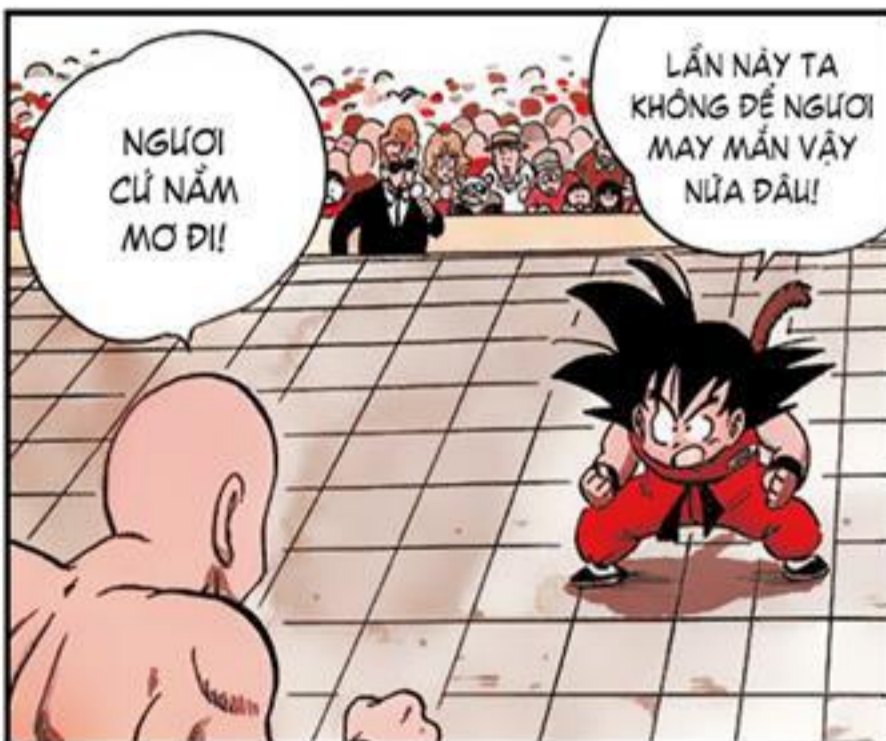







# ドラゴンボール

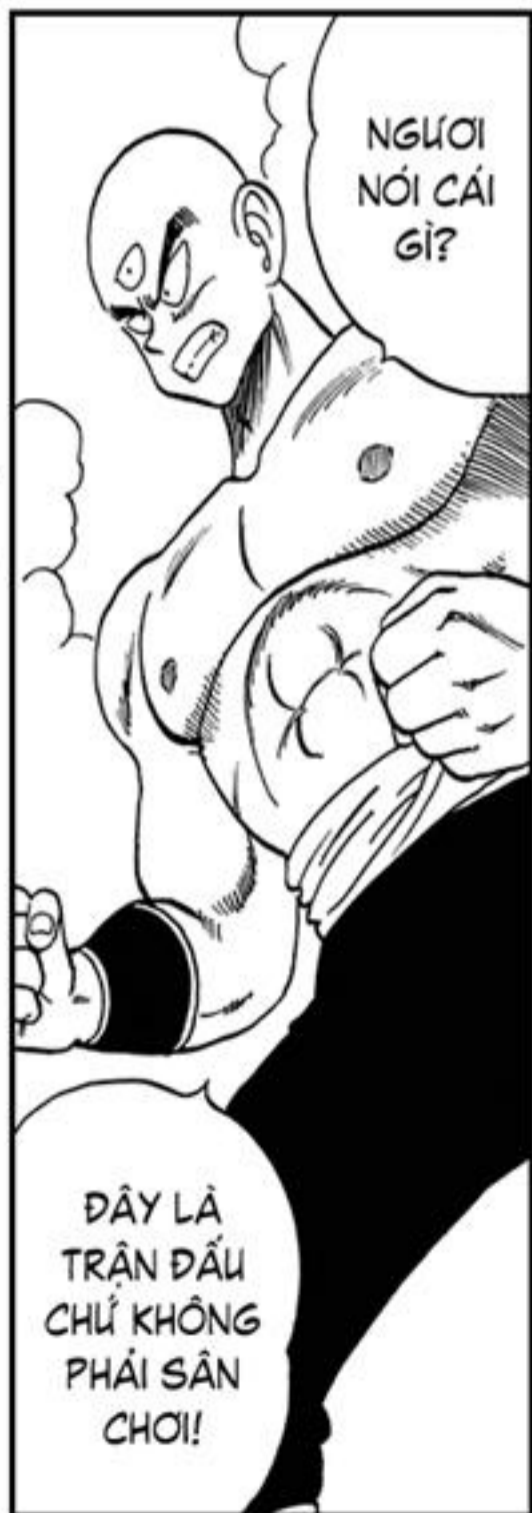



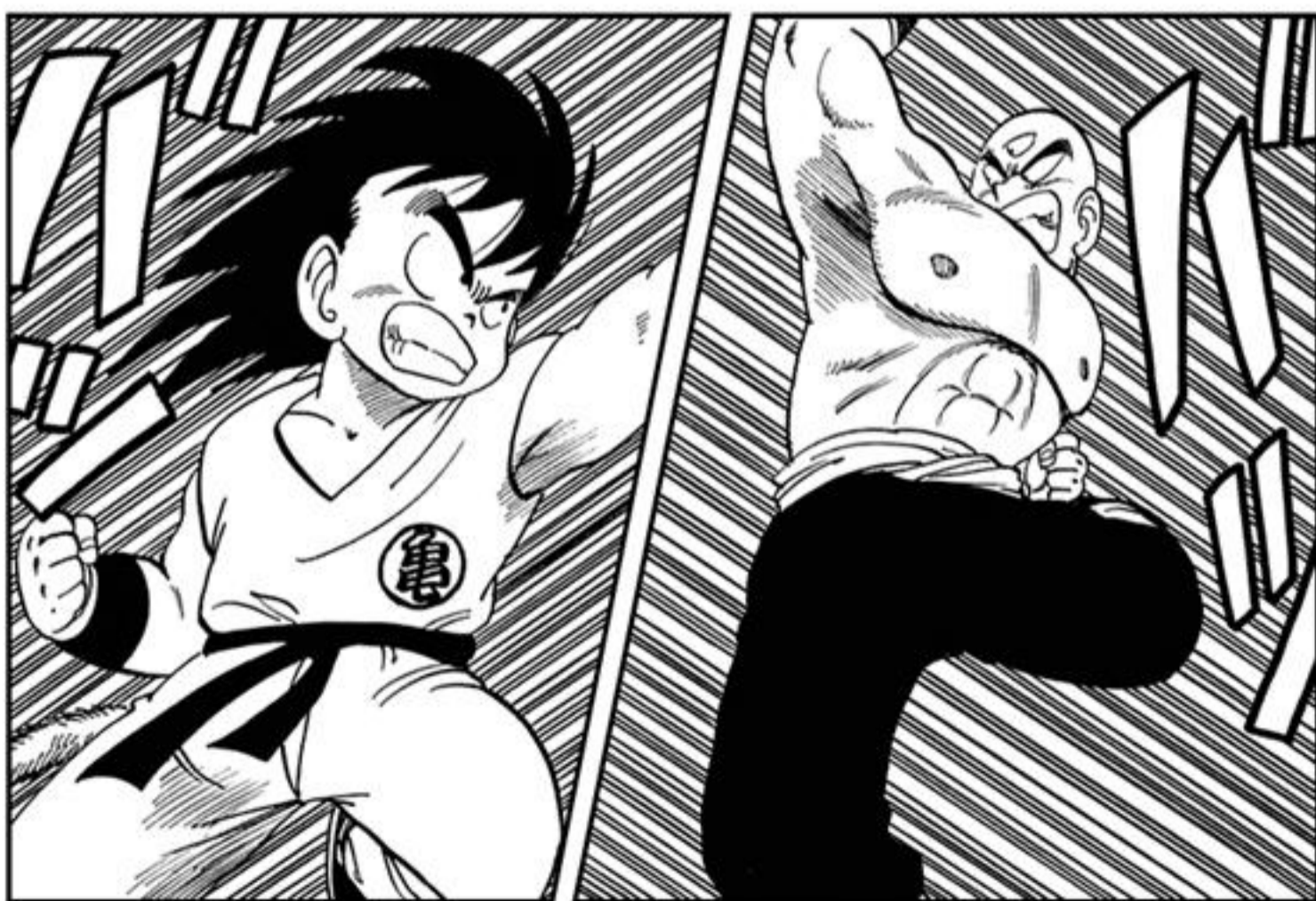
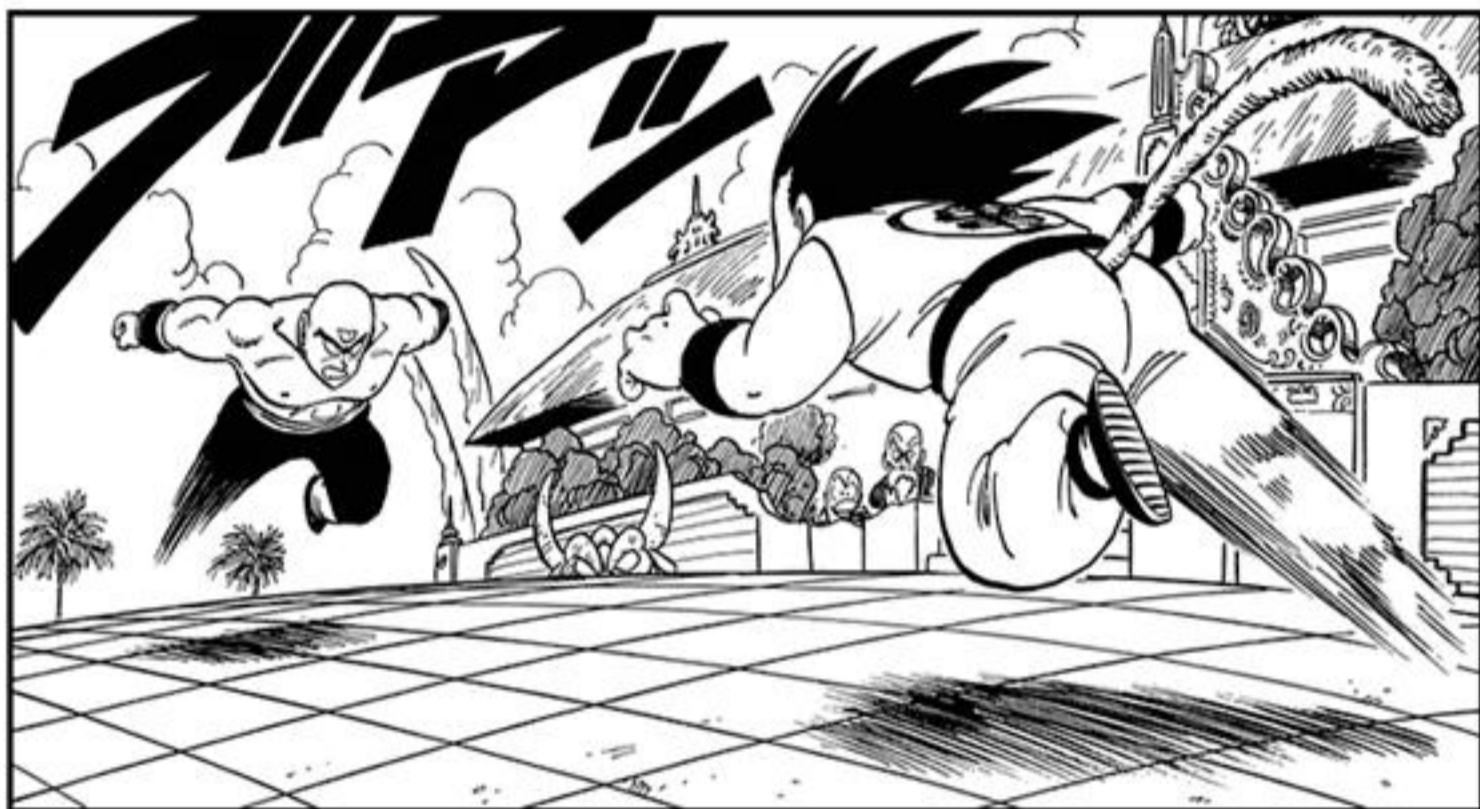

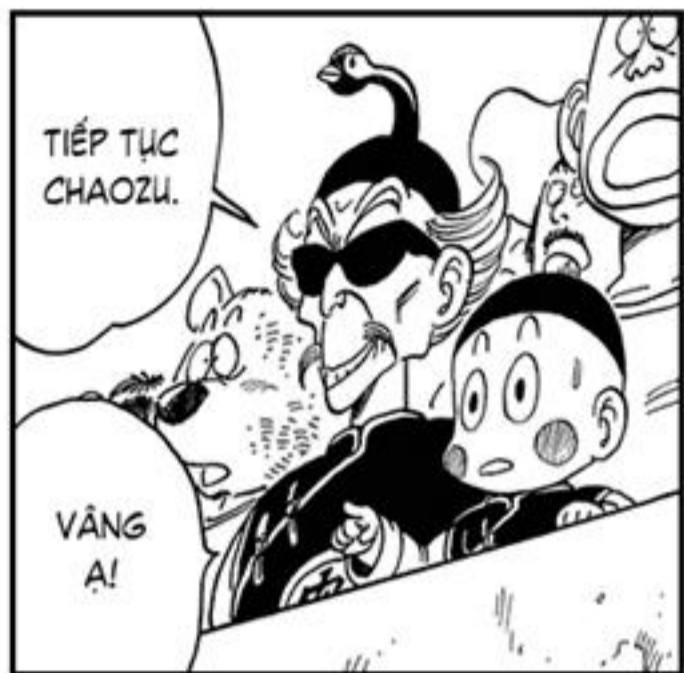
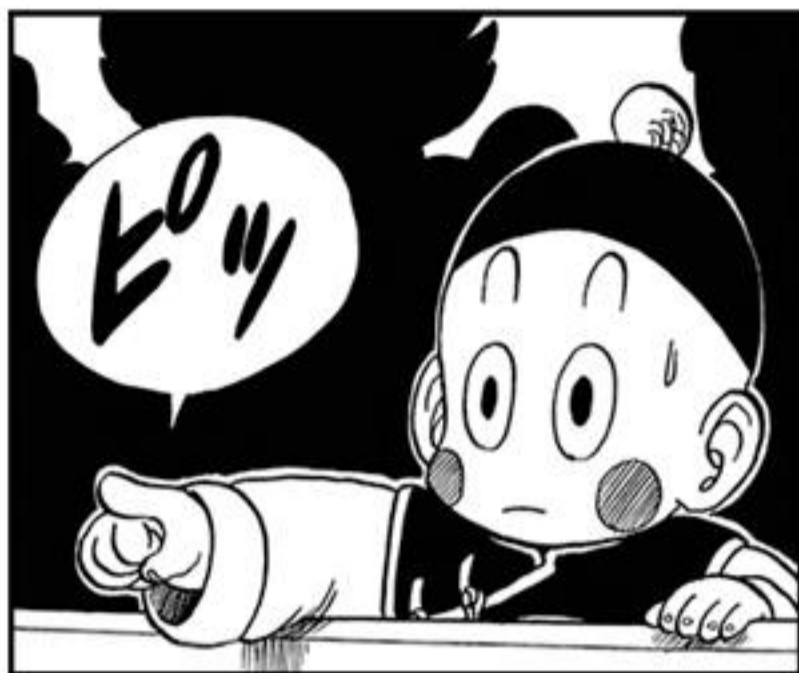

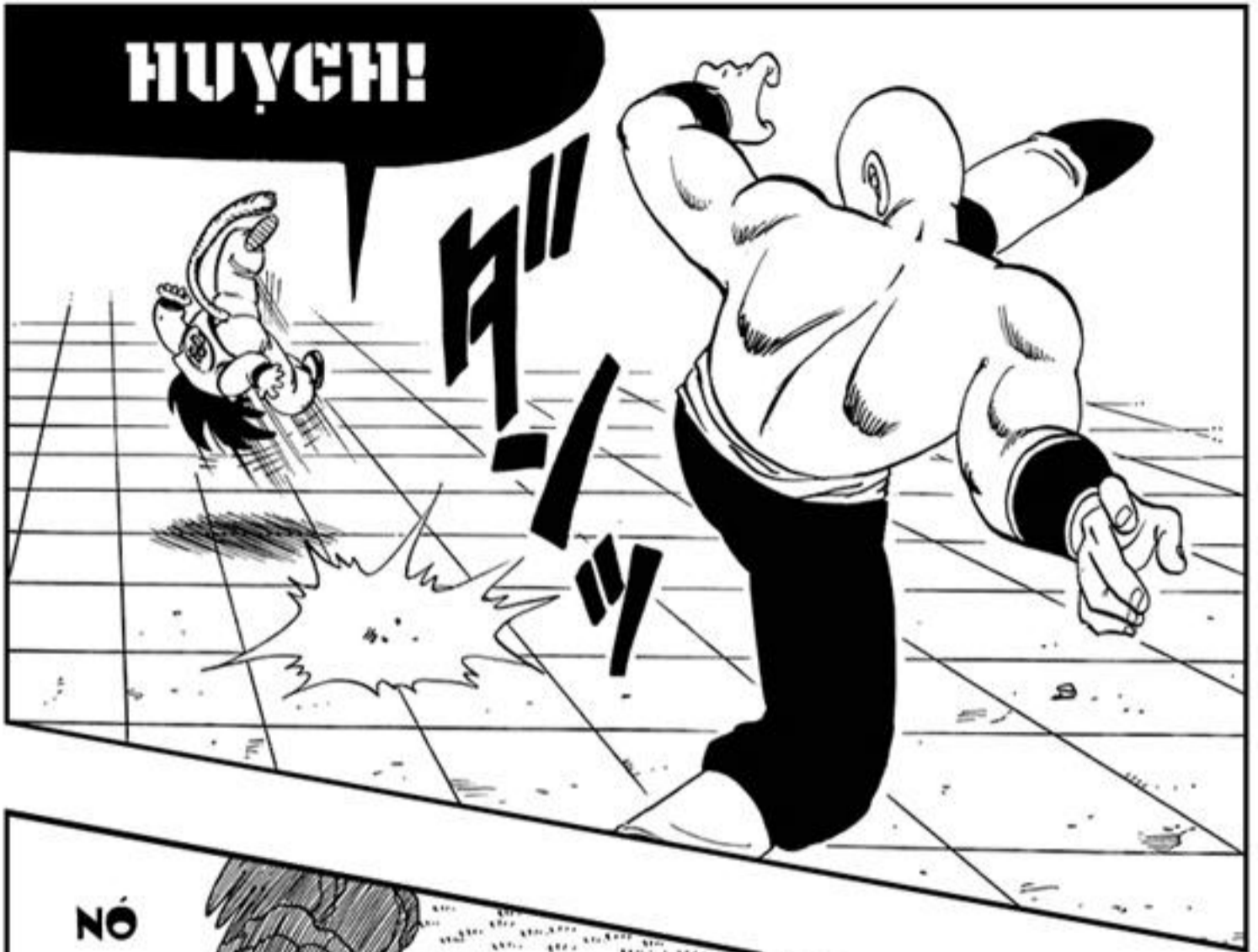

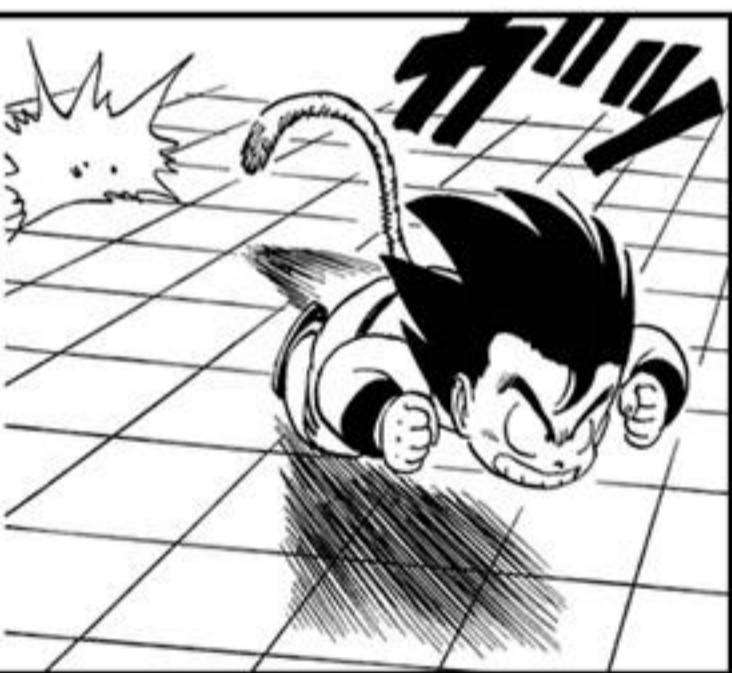

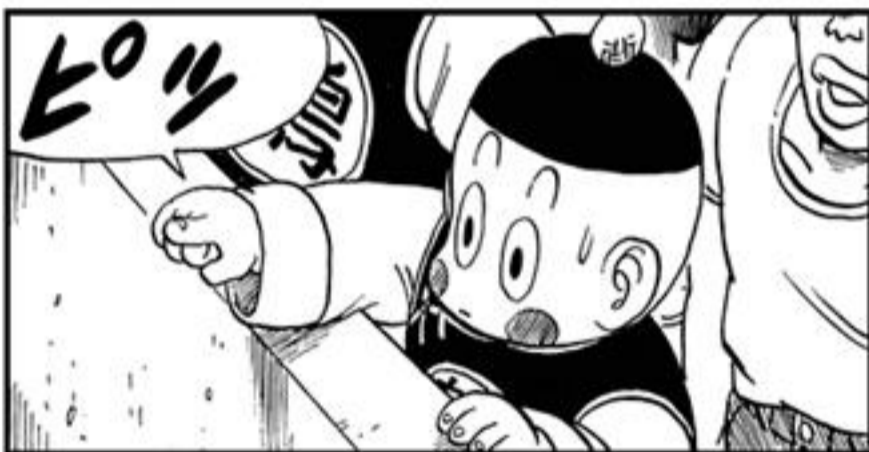
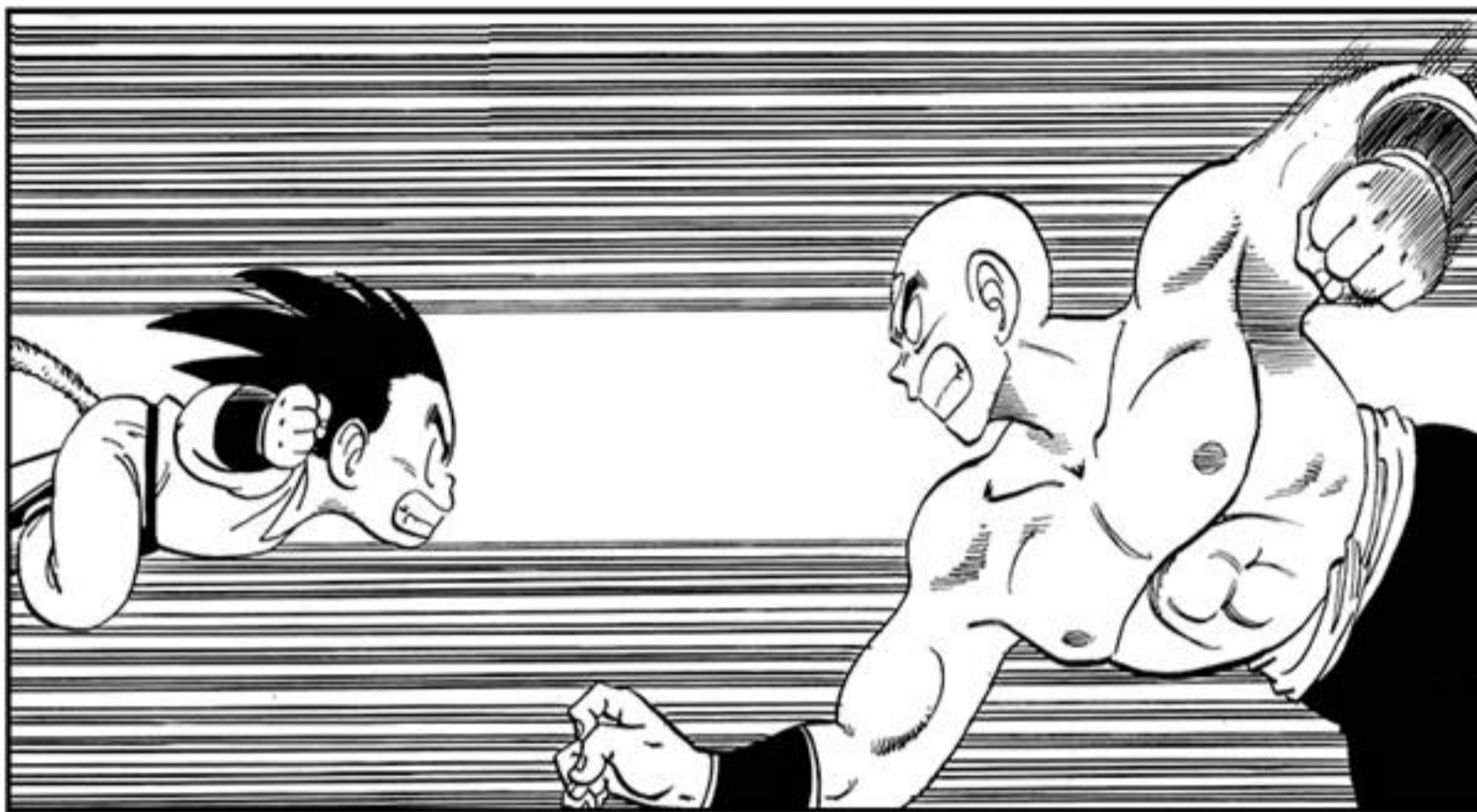



Có vẻ cậu bé đã bị K.O!

Gokuu gục hoàn toàn rồi!



LẠ QUÁ...



VÀNG A.



giải quyết đi! giết nó mau!



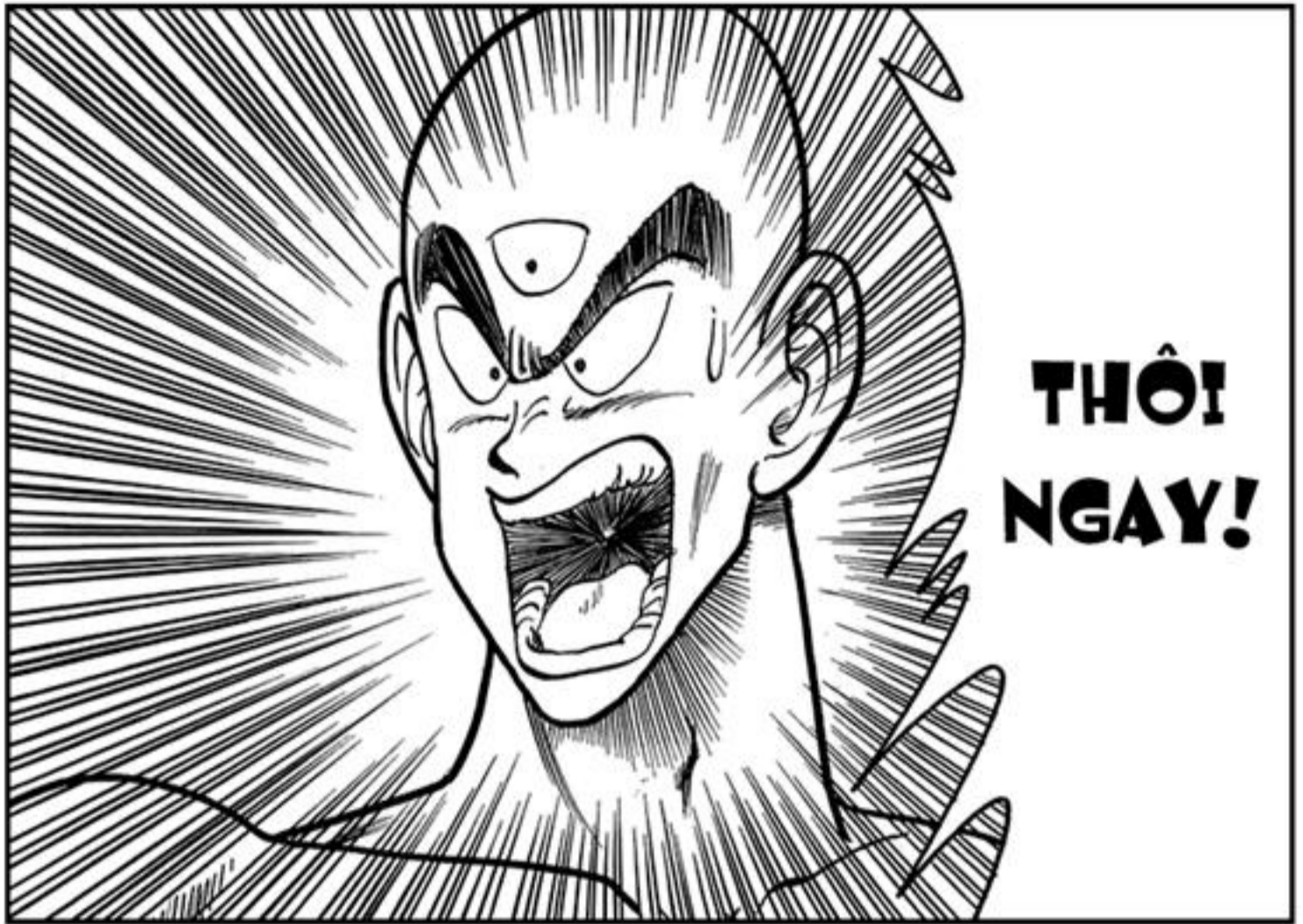



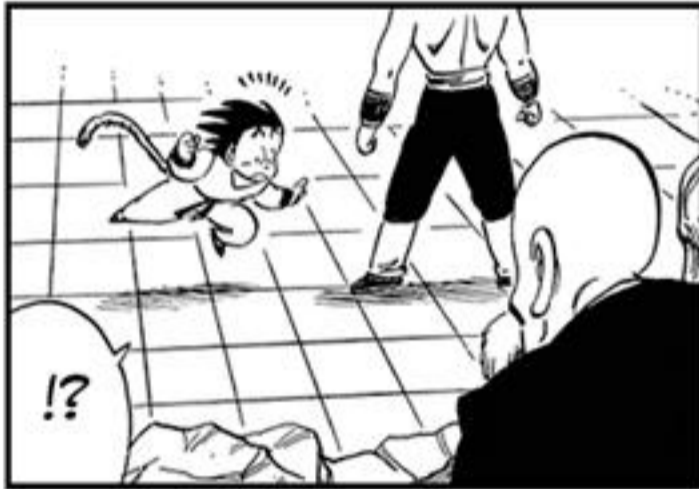



HƠN NỮA, CON  
KHÔNG PHẢI KẸ  
GIẾT NGƯỜI.

KHÔNG! NẾU  
GIẾT NÓ, CON  
SẼ BỊ LOẠI...



MÀY BỊ  
LÃO RÙA  
TẮY NÀO  
RỒI!

MÀY  
VỪA NÓI  
GÌ HẢ!?



CHAOZU,  
ĐÔNG  
CÙNG  
CHUNG  
NÓ!

TAO SẼ  
GIẾT CẢ  
HAI ĐỨA  
MÀY!

THẮNG VÔ ON  
BẠC NGHĨA!  
MÀY NỢ TAO  
TẤT CẢ!



CHAO  
ZU!





CÁ MÀY  
NỮA À!?

ㄟㄟ



CON  
MUỐN  
XEM TỚI  
KHI TRẬN  
ĐẤU KẾT  
THỨC.

TIỀN ĐANG  
ĐẤU MÀ SỰ  
PHỤ...



**CHAO  
ZU!!**



CÁI  
G-?

**TRÁNH  
RA!**



**KẸ NÀO  
NGÀNG  
ĐƯƠNG TẠO  
ĐỀU PHẢI  
CHẾT!**

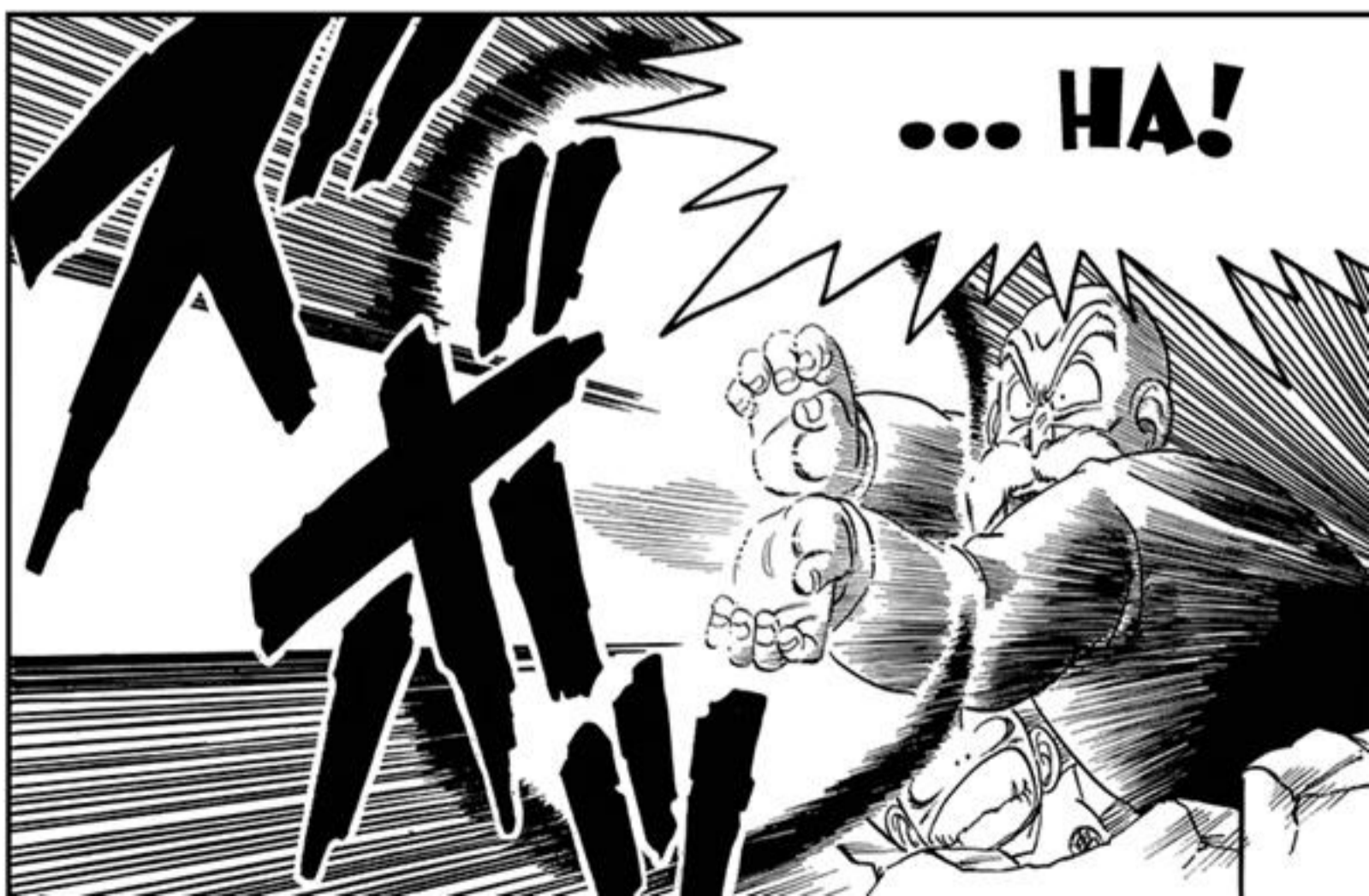

**... HA!**



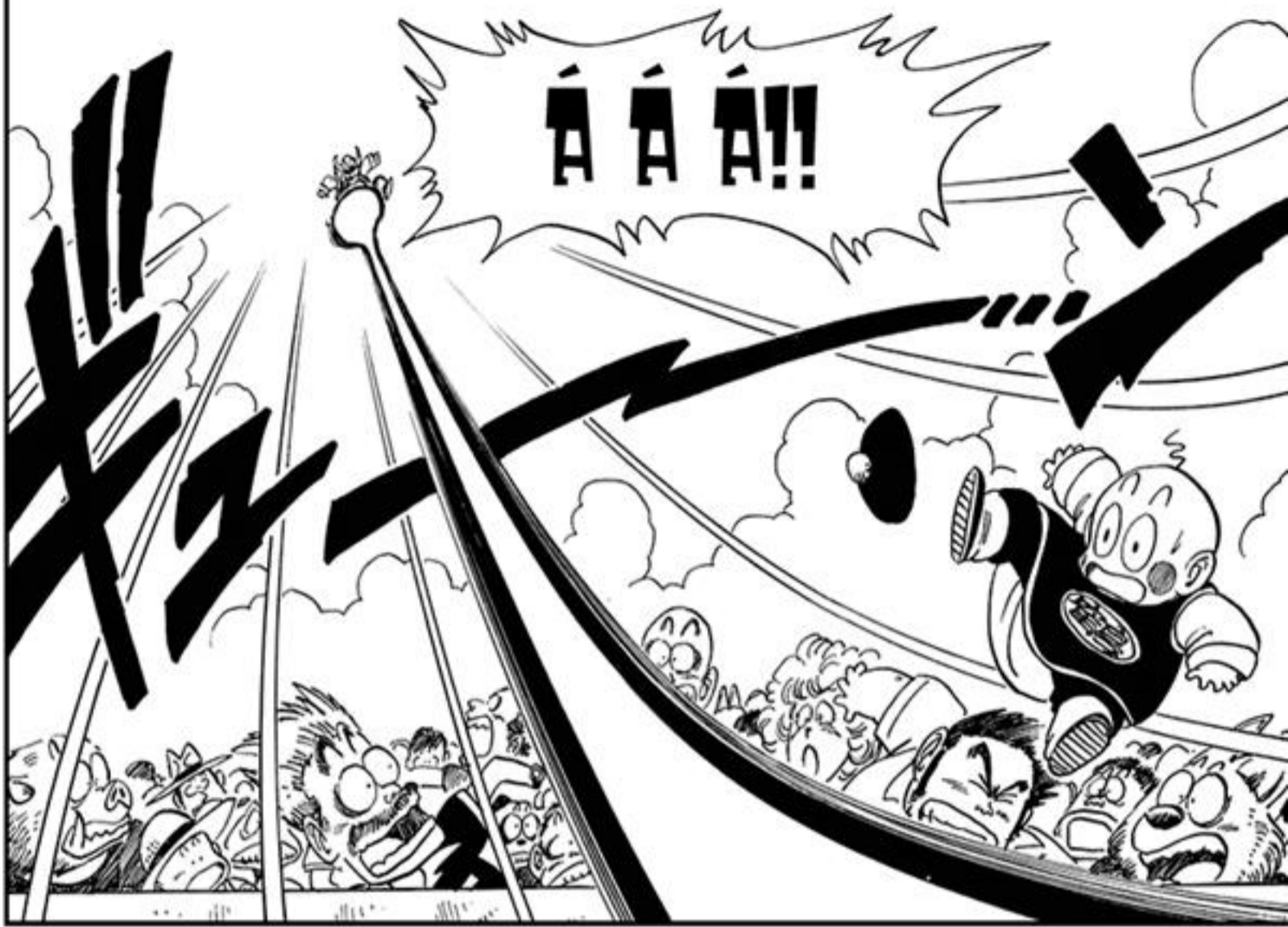



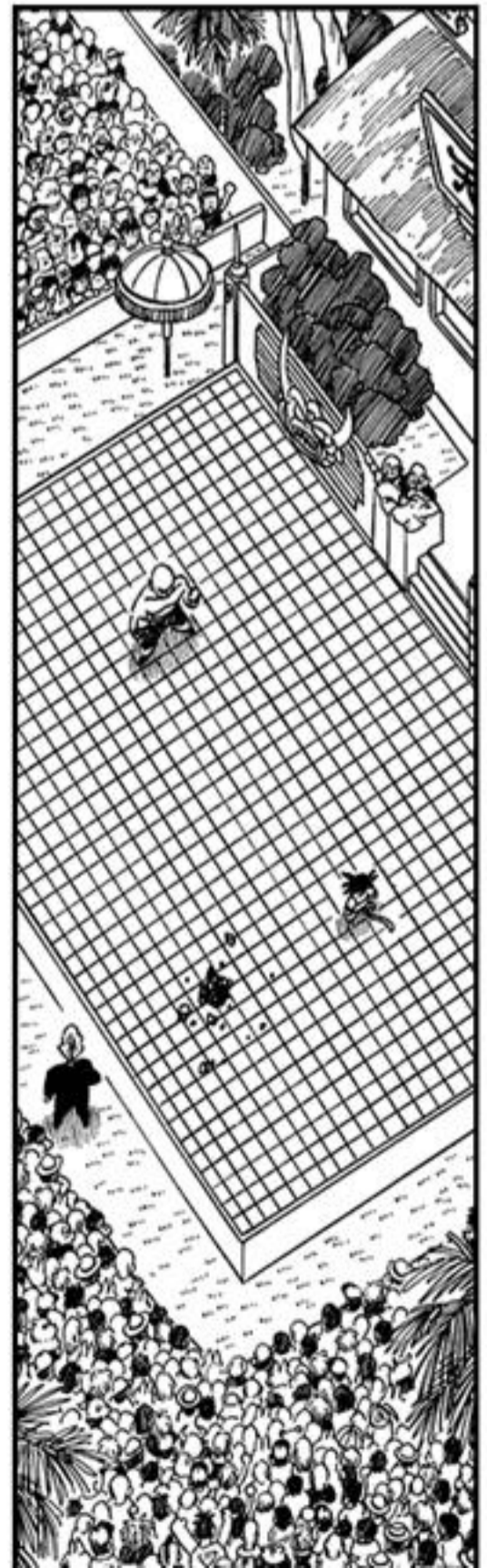



DỪNG...  
DỪNG LÀ  
ANH ẤY  
ĐỊNH DỪNG  
ĐÒN ĐÓ  
RỒI!



NÓ  
ĐỊNH  
TUNG  
CHIÊU  
GÌ  
VẬY?

HÁ?



Ư Ư...  
GAAAA  
AAH...!



!?

Tien  
đường như  
đang chuẩn  
bị làm gì đó  
thưa các  
bạn...



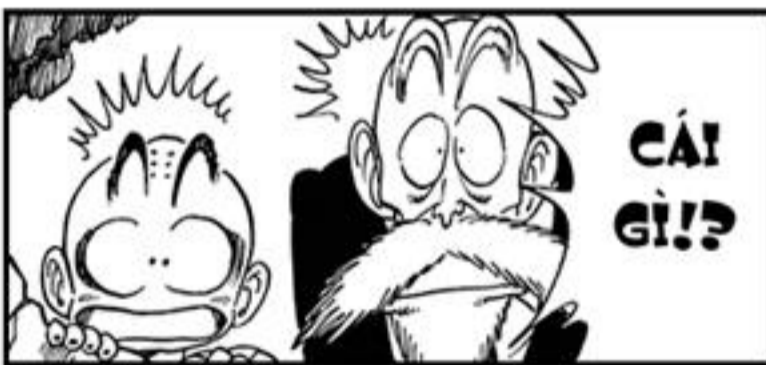
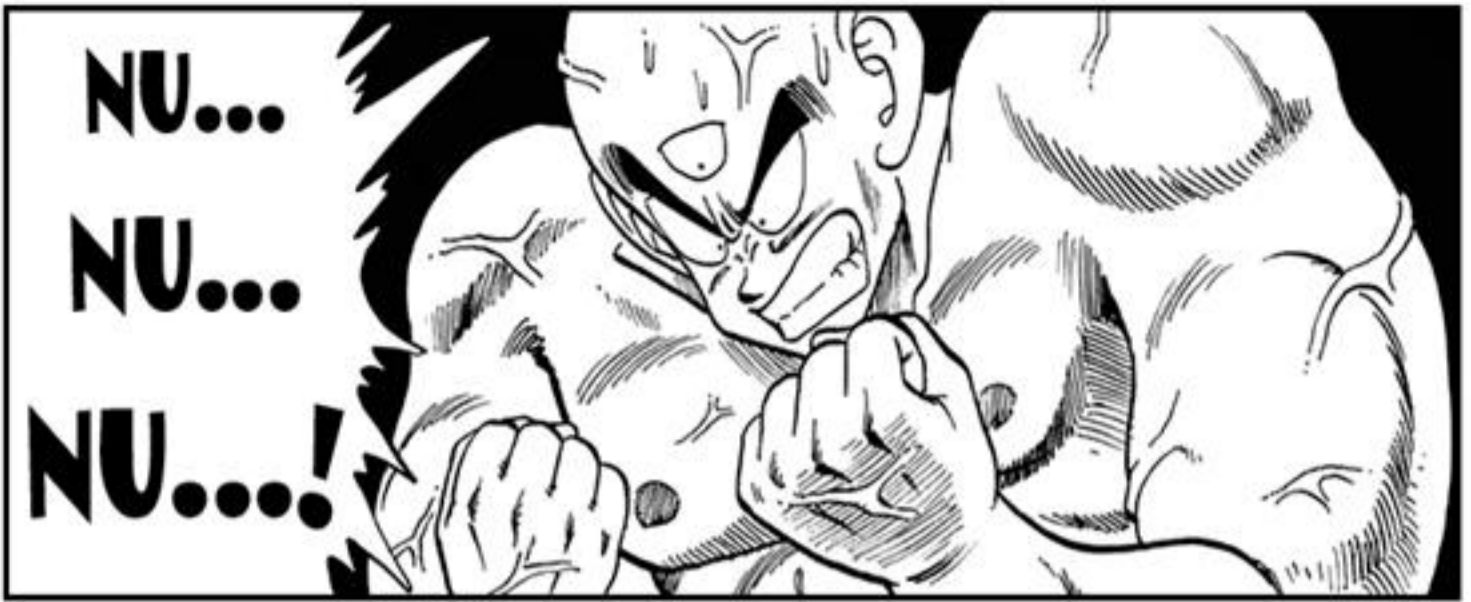





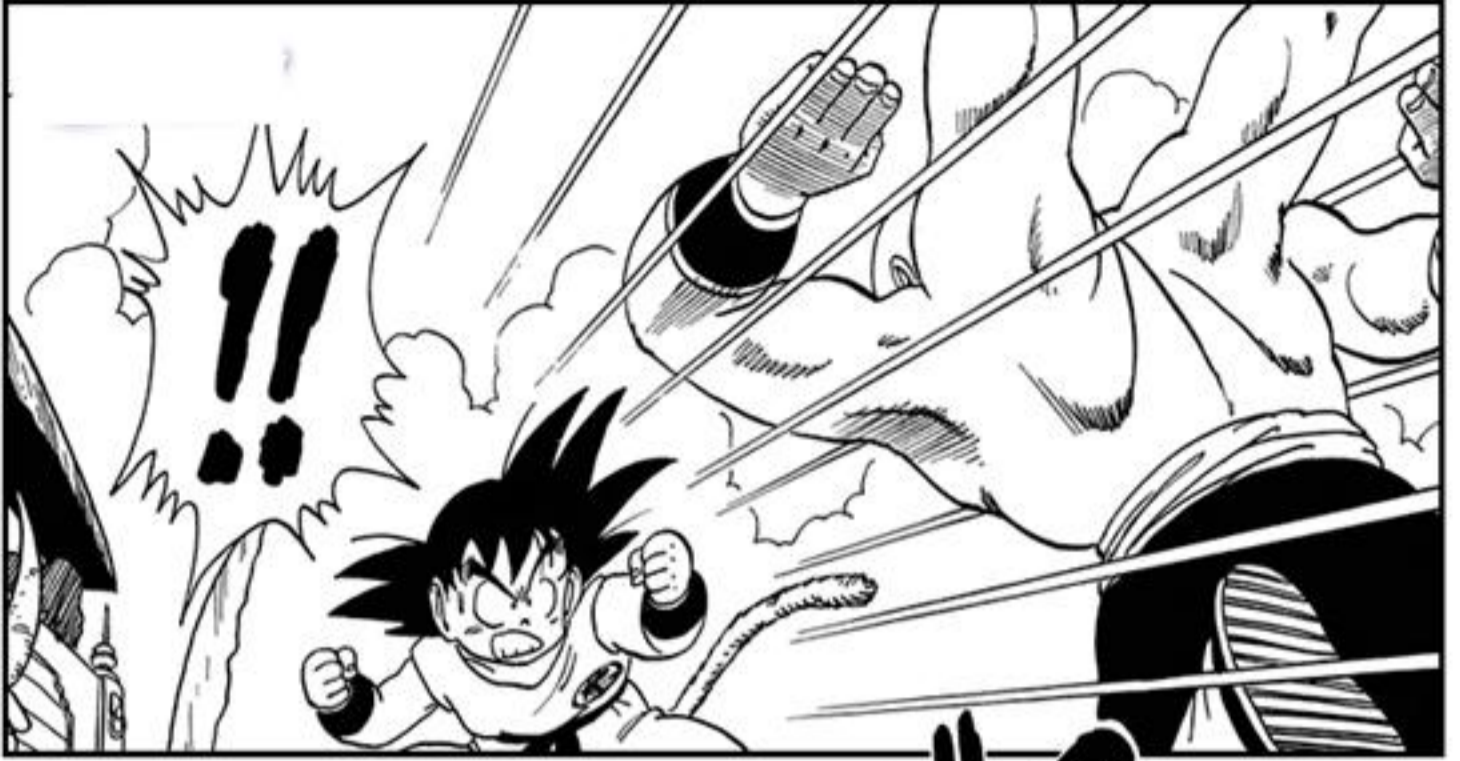

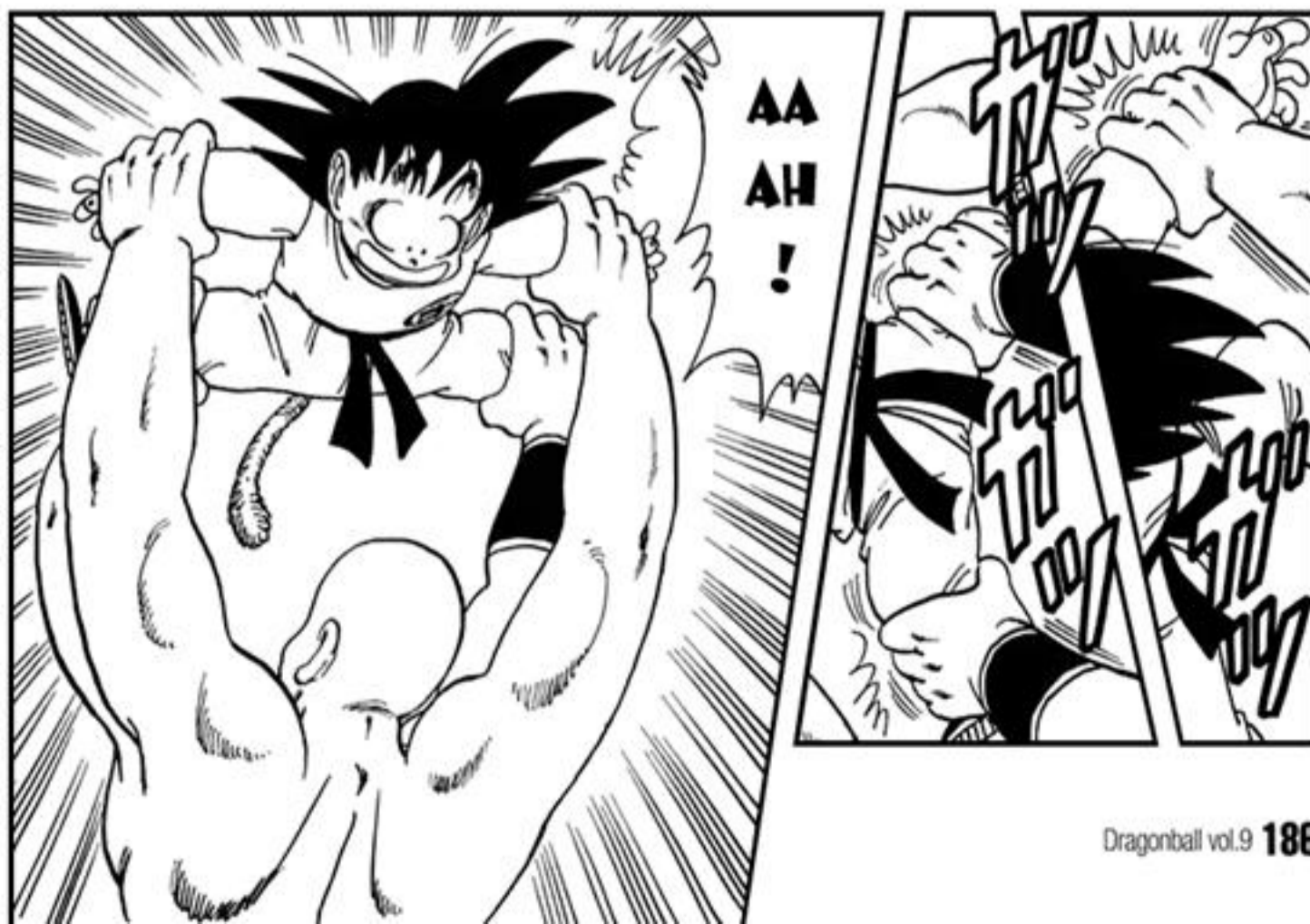
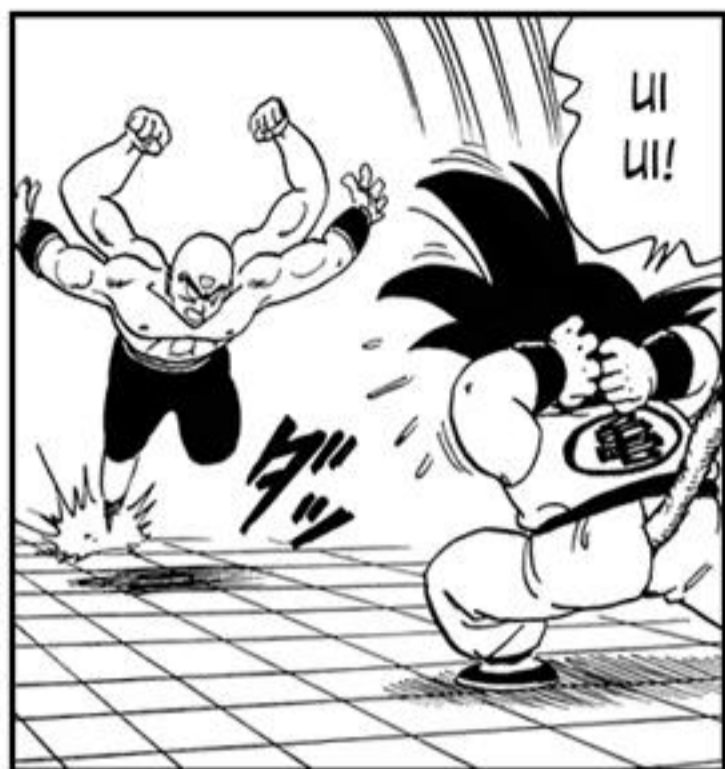

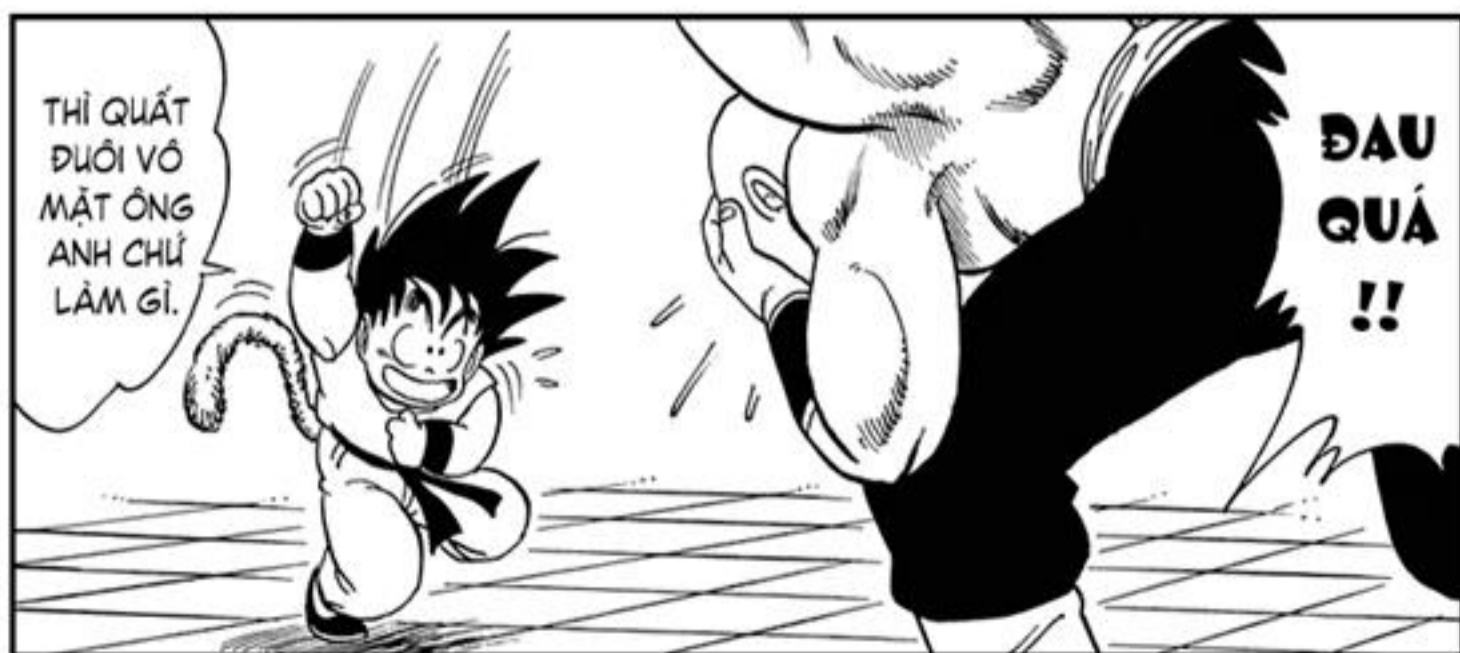











**NÊN DIỆT  
MÌNH THÌ  
TRÁNH ĐI, RỒ  
CHƯA? ĐỪNG  
CÓ NGOAN  
CÓ NGẠNH  
KHÁNG!**

**NHƯNG  
TA KHÔNG  
HỀ MUỐN  
NGƯỜI  
CHẾT!**



**LÊ  
NÀO...**



**CÁI GÌ  
THẾ?**

**NGẠNH  
KHÁNG?**



**?!**



**HÁ?**



**TIỆN!  
THỀ  
QUÁ  
NGUY  
HIỂM!**

**RA LÀ  
THỀ!**



**TIỆN!  
ĐỪNG  
LÀM  
THỀ!**

**ANH  
ÀY  
ĐỊNH  
ĐỪNG  
KIKO  
HO...**



**SƯ PHỤ!  
CÁI ĐÓ  
LÀ...?**

**KIKOHO...  
KHÔNG  
THỂ TIN  
ĐƯỢC...**

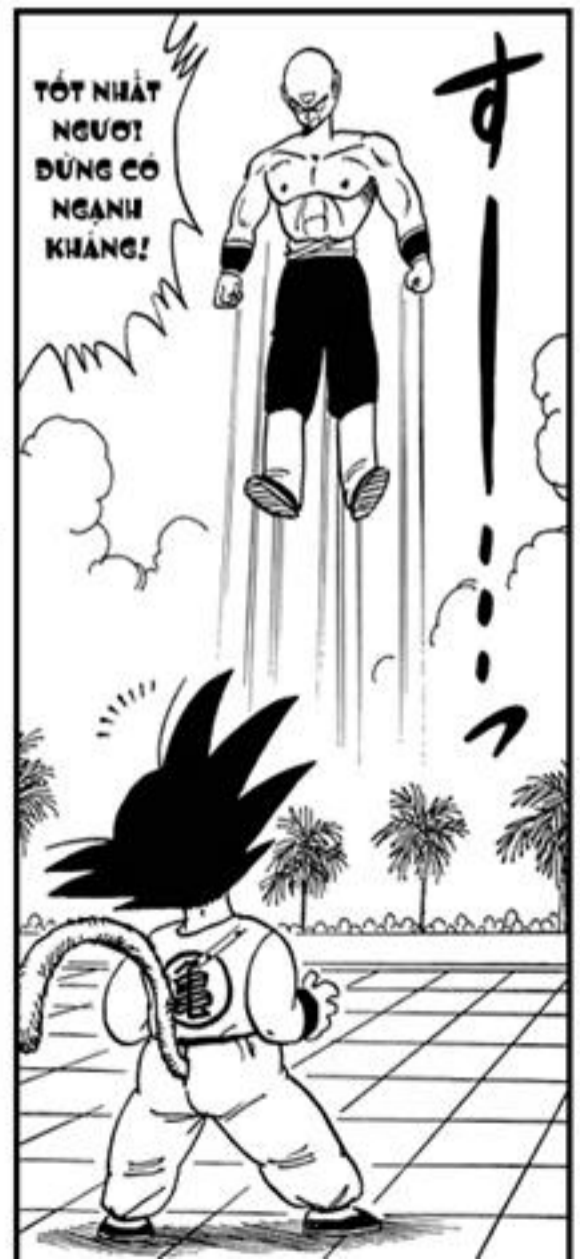



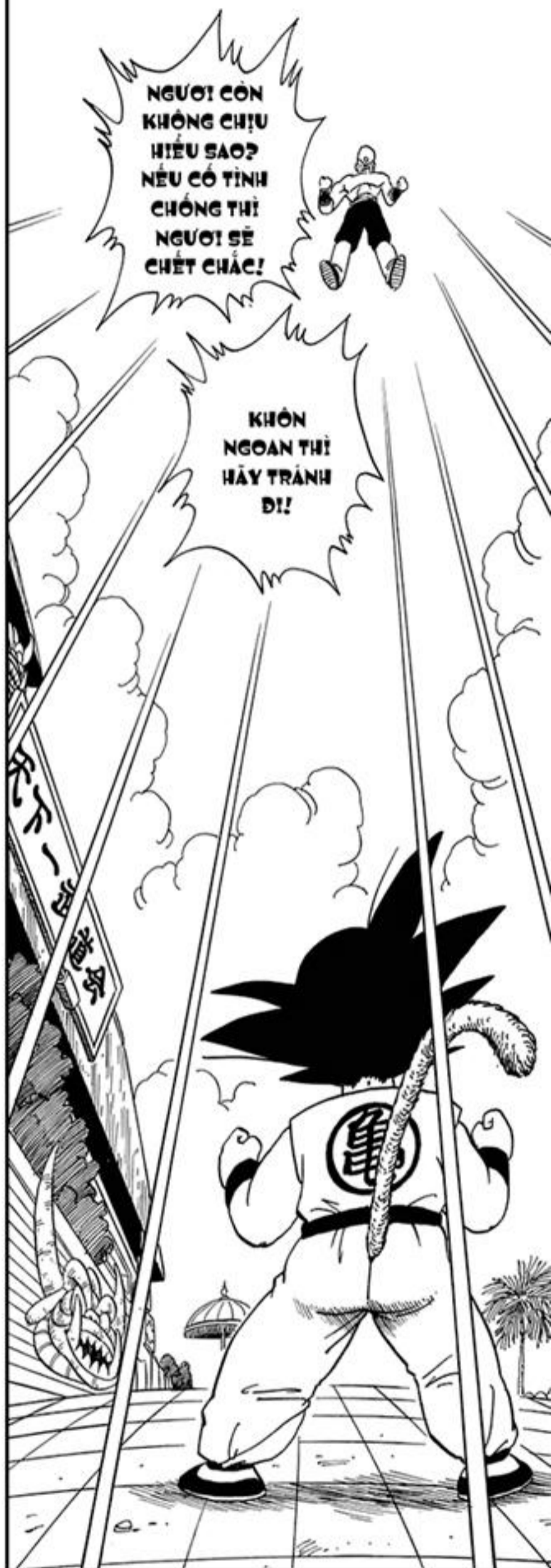



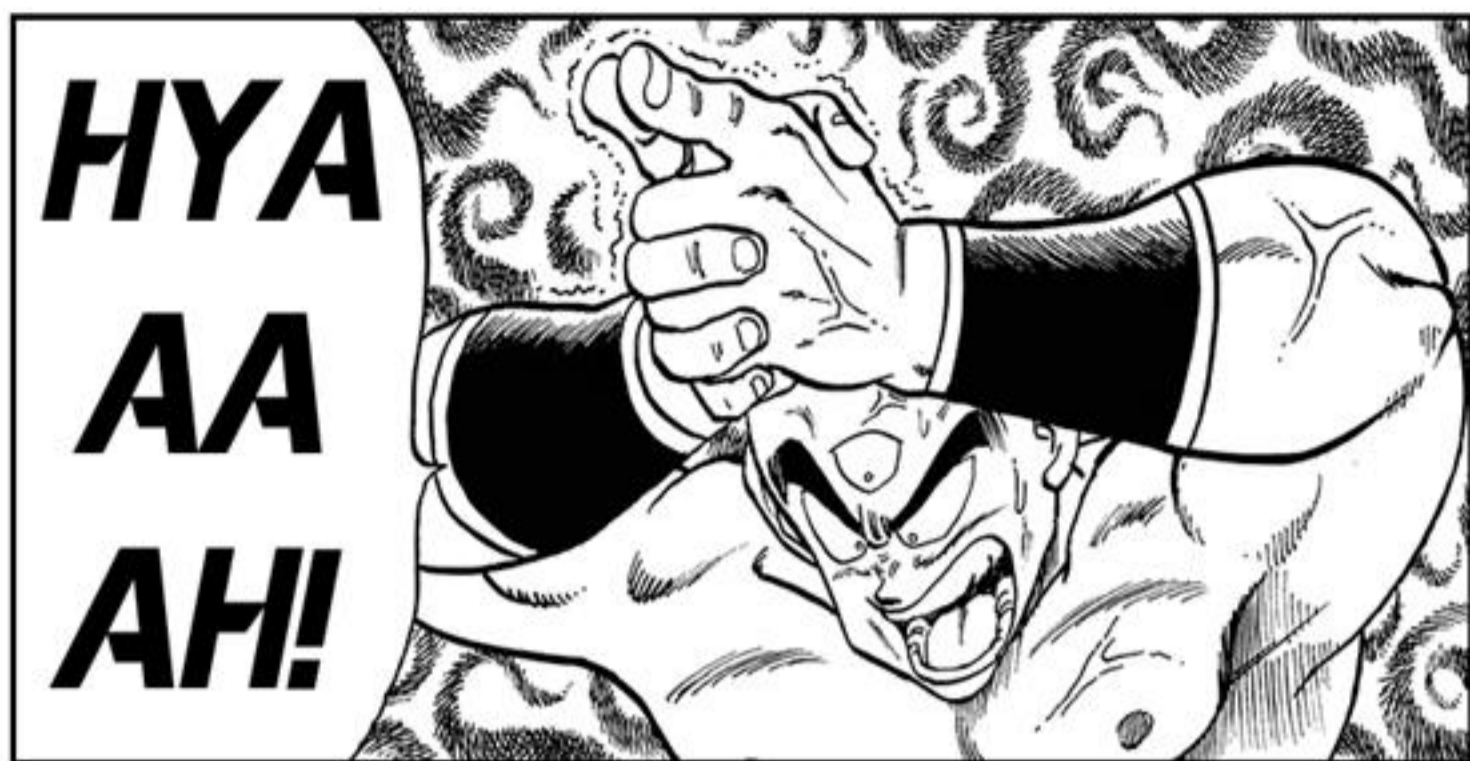



... TRUNG  
TÂM VÔ  
ĐÀI...



XÁC ĐỊNH  
ĐÚNG  
PHƯƠNG  
HƯỚNG...



... ĐỂ PHÒNG  
TRƯỜNG HỢP  
NÓ THỰC SỰ  
CÓ THỂ NGÀNH  
KHÁNG RỐI  
PHẢN CÔNG.

CẦN PHẢI  
CẨN THẬN.  
MÌNH KHÔNG  
ĐƯỢC XUẤT  
TOÀN BỘ  
NĂNG  
LƯỢNG...



**KI-  
KO-  
HO-  
!!!!**











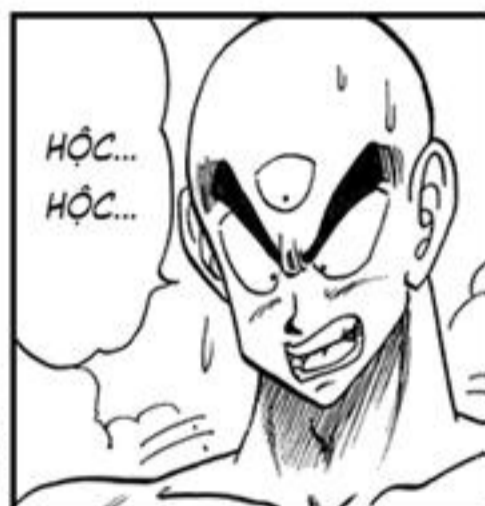

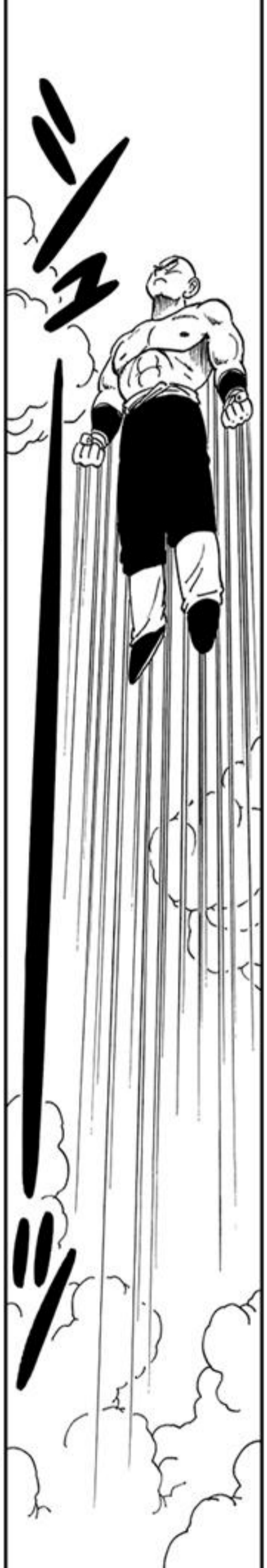



... TRẬN  
ĐẤU ĐÃ  
ĐƯỢC ĐỊNH  
ĐOẠT  
RỒI.

MÀ TA  
THÌ LẠI CÓ  
THỂ ĐĂNG  
KHÔNG...



.....



NÓI CÁCH  
KHÁC, AI  
CHẠM ĐẤT  
TRƯỚC THÌ KÉ  
ĐÓ THUA  
CUỘC.

NGƯỜI ĐANG  
TRÊN ĐÃ RƠI  
XUỐNG, NẾU  
NGƯỜI KHÔNG  
BIẾT THÌ TA XIN  
THÔNG BÁO LÀ  
PHÍA DƯỚI KHÔNG  
CÒN VỎ ĐÀI NÀO  
MÀ DỪNG ĐẤU.



CÁI  
GÌ?!



TA VẪN  
CÒN MỘT  
CƠ HỘI  
NỮA!



ỒI  
CHA!

HỪM...







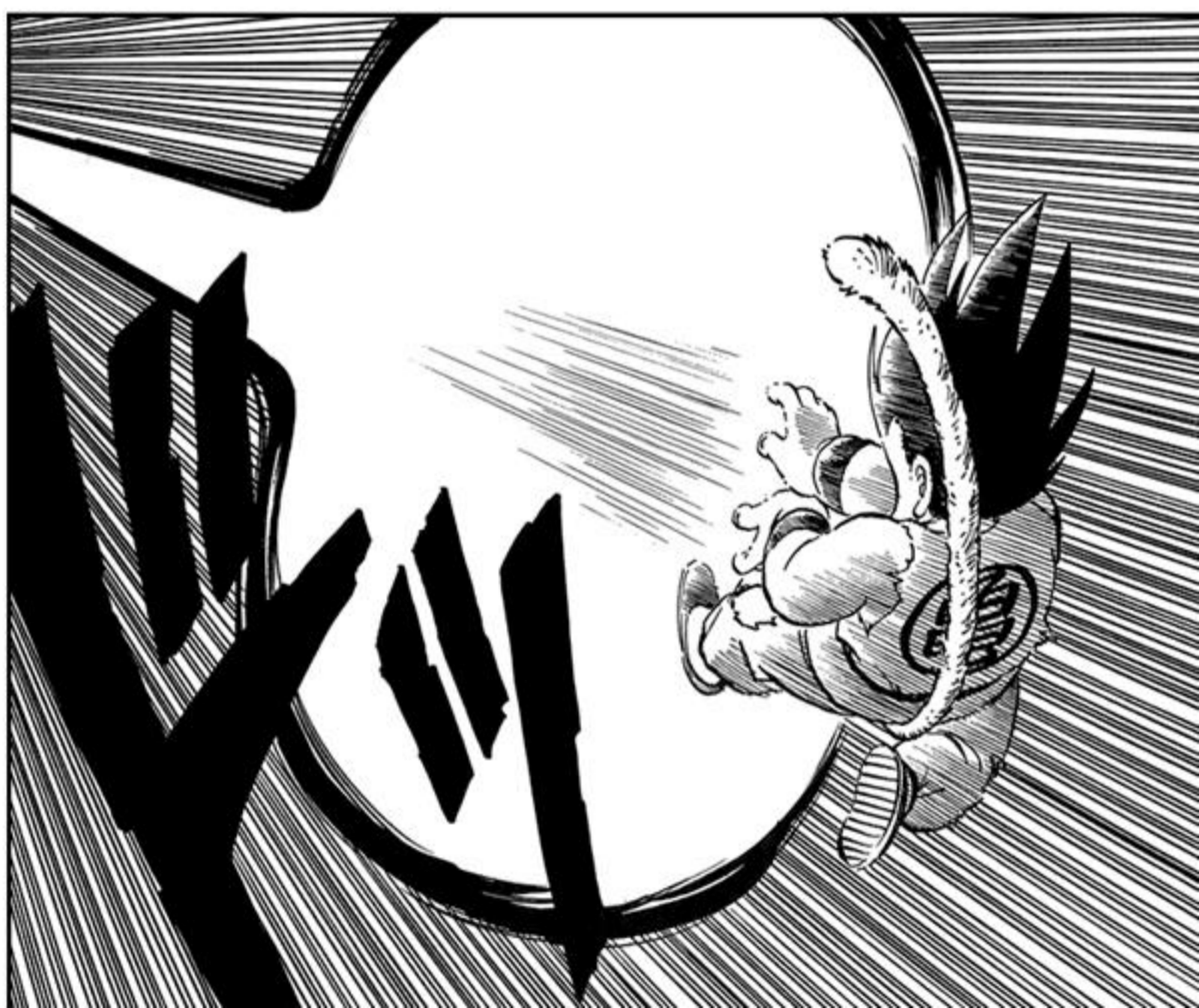



TRỜI  
ĐẤT  
THIỆN  
ĐỊA  
ƠI!\*

\*THẬT RA THÌ CHÁ HIẾU ỚNG NÓI GI LƯƠN!



SAO  
CÓ THỂ!  
NÓ..!



# DRAGON BALL

№134: TRÊN  
KHÔNG TRUNG





quyết không để  
lỡ hẹn với chức vô  
địch lần nữa, Gokuu  
đã tung ra đòn tối  
hậu của mình!

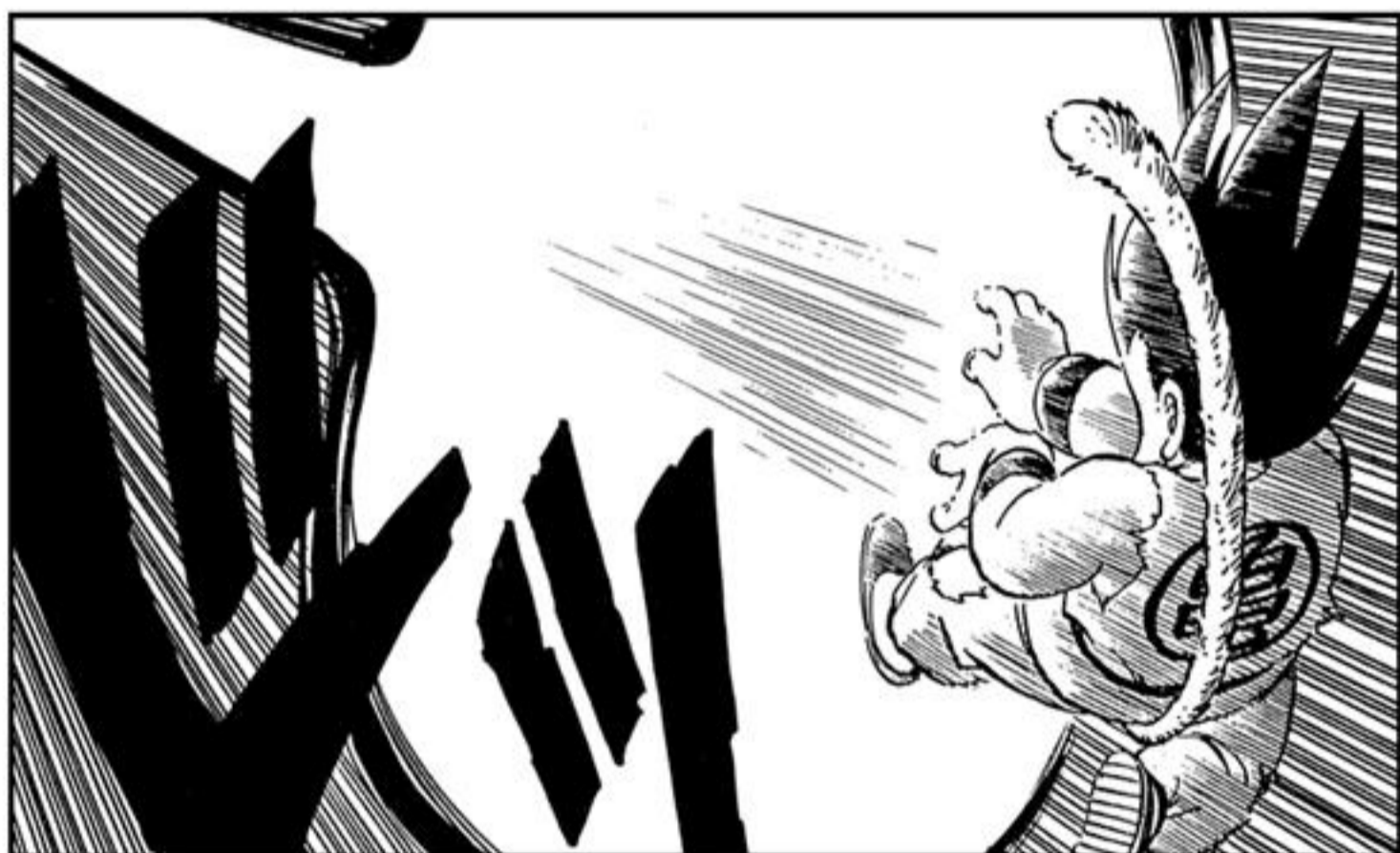



**ÔNG ANH  
NHANH LÀM  
SAO BẰNG  
TÔI ĐƯỢC!**



**CÁI...!  
SAO LẠI  
THẾ?!  
TA...!**



**TA  
HIỂU  
RỒI!  
GIỚI  
LÀM!**













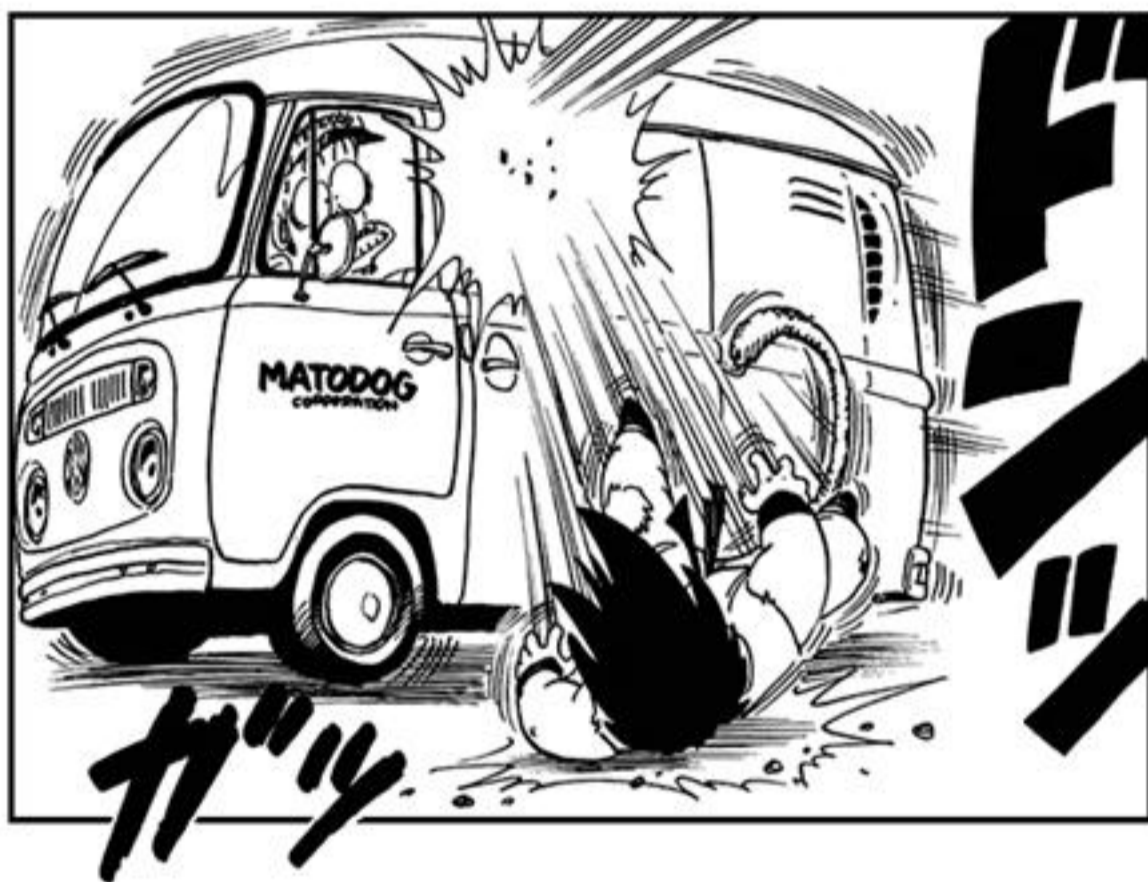
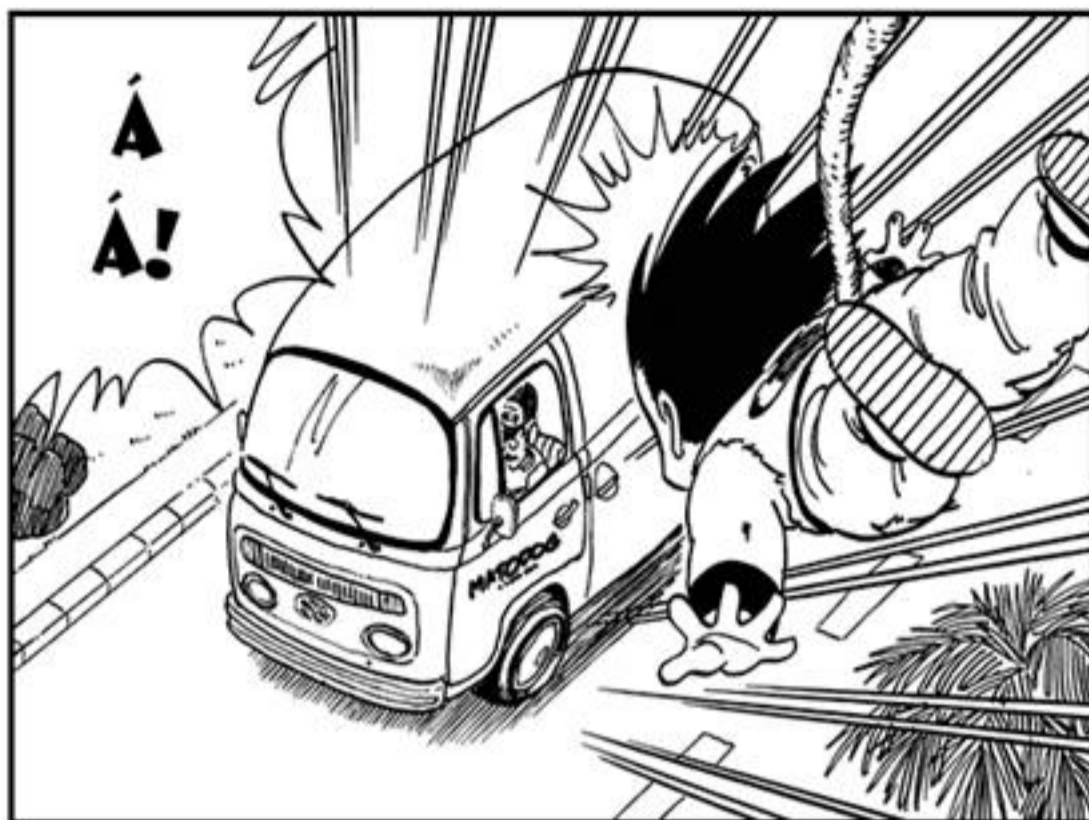

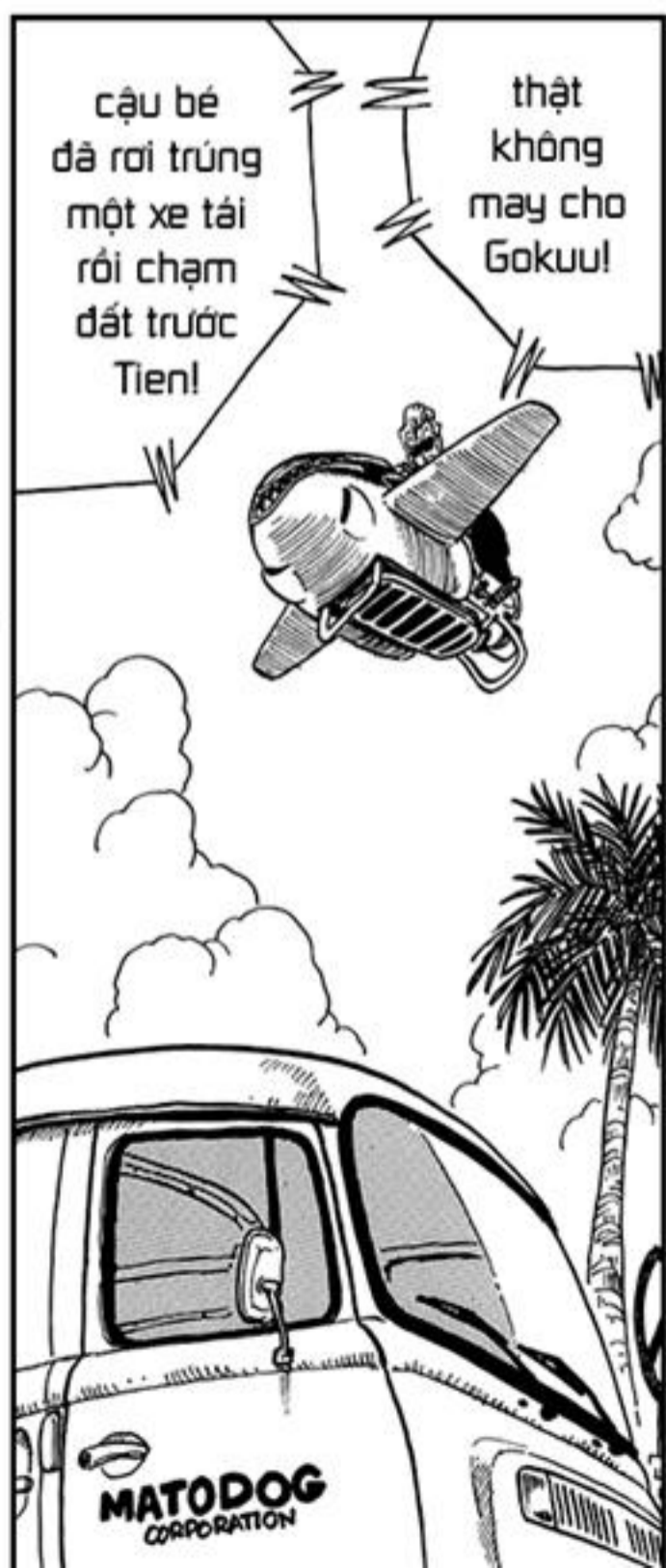
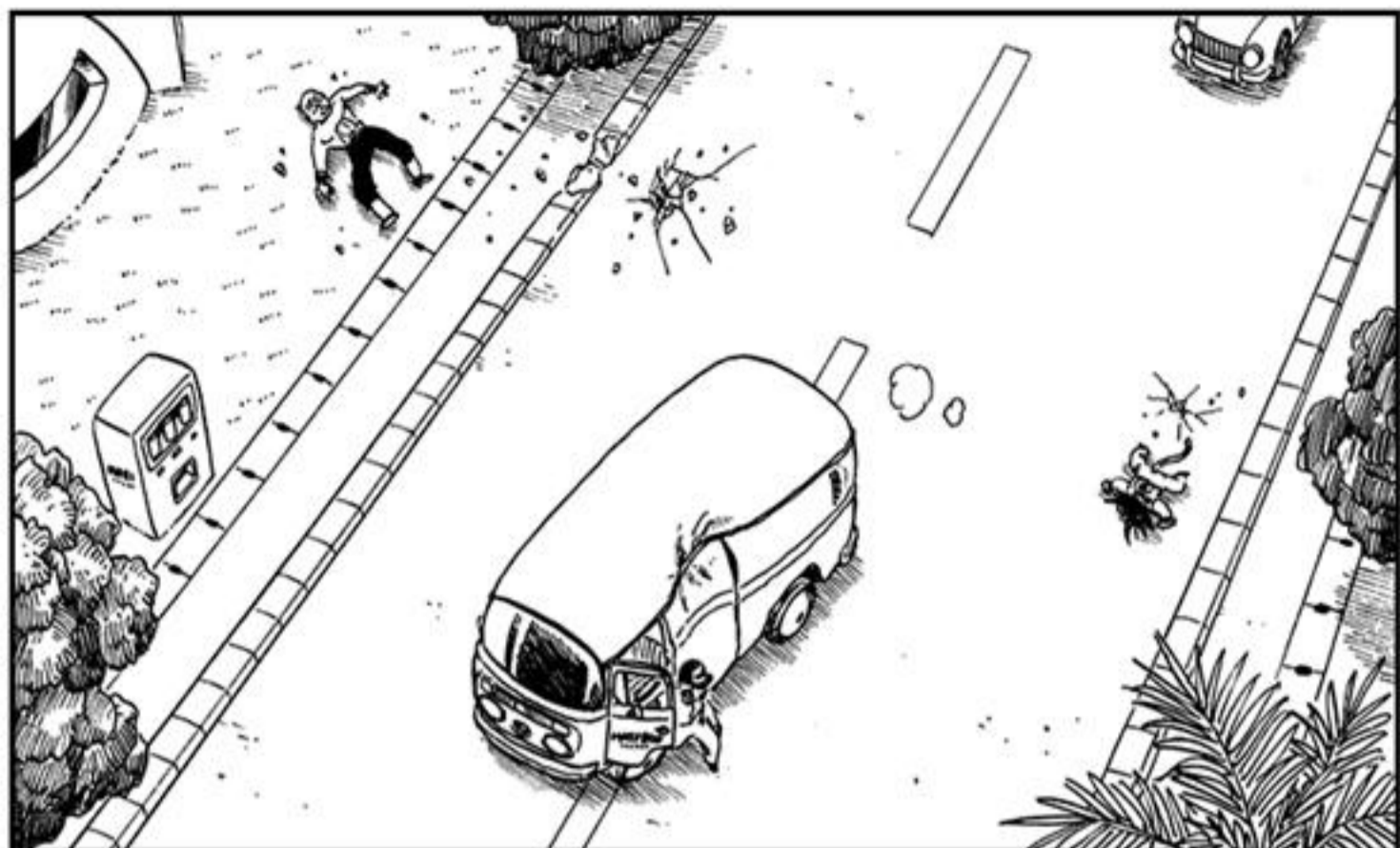

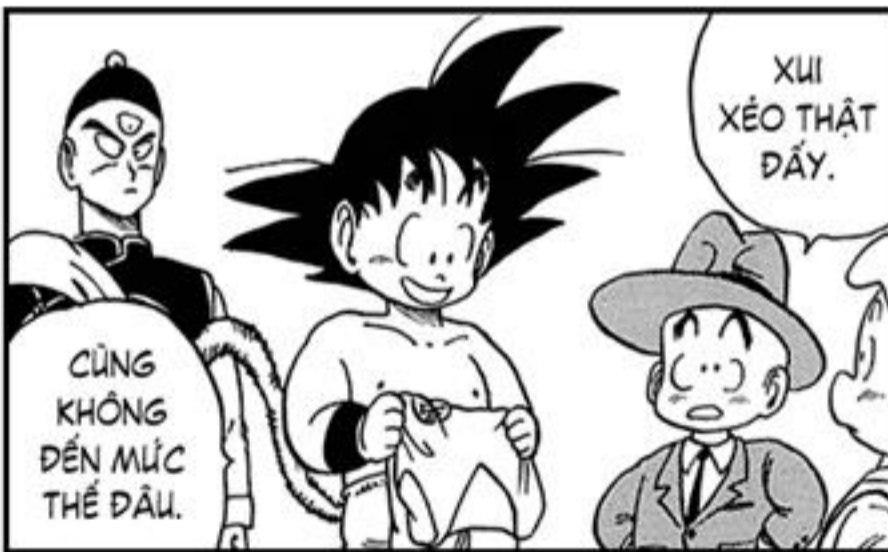



RÕ RÀNG  
CẬU XUẤT SẮC  
HƠN. CHIẾN  
THẮNG CỦA TÔI  
HOÀN TOÀN LÀ  
DO MAY MẮN.

THỰC RA  
CẬU MỚI LÀ  
NGƯỜI CHIẾN  
THẮNG. NÓ  
PHẢI LÀ CỦA  
CẬU MỚI  
ĐÚNG.



ĂN UỐNG  
ĐẦY ĐỦ CHO  
HỒI LẠI SỨC  
LỰC ĐÃ.

CHÚC TA  
ĐI ĂN TỐI  
CHỮ NHÌ?

ĐỪNG  
RỒI.



ĐỪNG  
THẾ.

ĐỪNG NÓI THẾ,  
MỘT VÔ SỰ ĐẠI TÀI  
CÙNG CẦN PHẢI CÓ  
MAY MẮN ĐI CÙNG.  
HƠN NỮA, GOKU  
CÙNG ĐÃ HỌC ĐƯỢC  
RẤT NHIỀU ĐIỀU TỪ  
KHI GẶP CẬU.



?

CẬU KHÔNG  
BIẾT MÌNH VỪA  
PHẠM SAI LẦM  
GÌ ĐÂU!

HE HE  
HE!



TÔI SẼ  
BAO MỌI  
NGƯỜI  
TIỀN ĂN.



CÁ  
NYOIBO  
NỮA! ĐÂU  
RỒI NHÌ?

Ơ,  
NGỌC  
RỒNG  
CỦA  
TÔI!

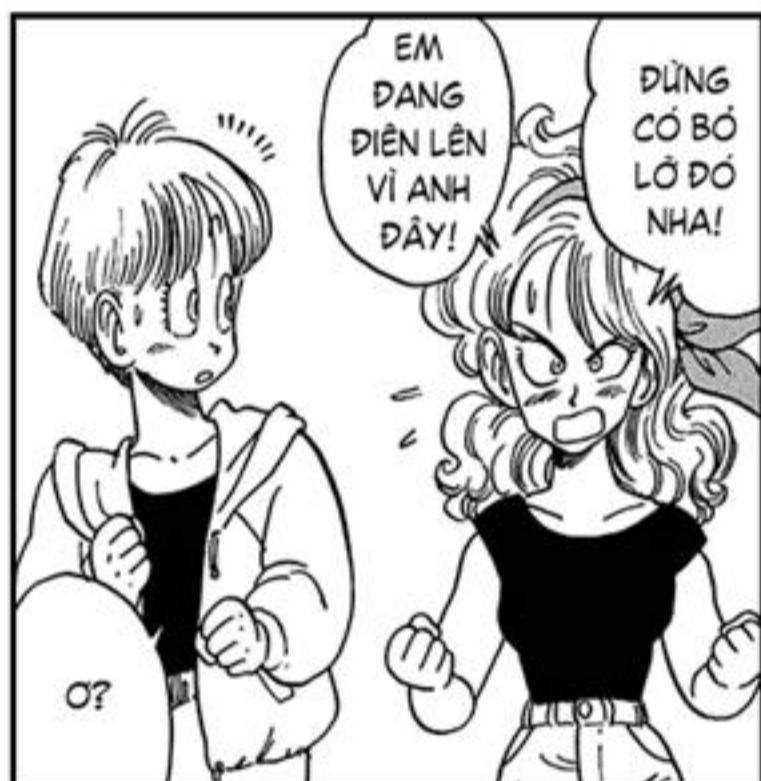







# PHAN THƯỚC

ジャンプ・コミックス

## ドラゴンボール完全版

09

2003年4月9日 第1刷発行

---

著者 **鳥山明** ©BIRD STUDIO 2003

編集協力 **株式会社 尚企画**

東京都千代田区神田神保町2-8-20 MTビル2F  
〒101-0051

編集人 **茨木政彦**

発行人 **鳥嶋和彦**

発行所 **株式会社 集英社**

東京都千代田区一ツ橋2丁目5番10号  
〒101-8050

電話 東京

03(3230)6233(編集)

03(3230)6191(販売)

03(3230)6076(制作)

Printed in Japan

印刷所 **大日本印刷株式会社**

造本には十分注意しておりますが、乱丁・落丁（本のページ順序の間違いや抜け落ち）の場合はお取り替え致します。購入された書店名を明記して、集英社制作部宛にお送り下さい。送料は集英社負担でお取り替え致します。但し、古書店で購入したものについてはお取り替え出来ません。本書の一部または全部を無断で複写、複製することは、法律で認められた場合を除き、著作権の侵害となります。

---

ISBN4-08-873452-1 C9979

Jump Comics  
**Dragonball**  
by Toriyama Akira

**09**